

NewXS Fixturing system

Catalogue 2016^{E06}



Modular fixturing system
for optical measuring and
checking instruments





Hightech in Aluminium

Witte was founded in 1969 and initially manufactured complex, high-precision parts for the aerospace industry. Today Witte has developed into a leading manufacturer of fixturing systems and gauges for all kinds of applications.

Almost all leading companies from automotive and aircraft industries now rely on Witte technology in order to maintain high quality in their production process.

Among a broad range our emphasis lies on development and manufac-

ture of advanced workpiece clamping systems for universal application. Witte has taken up the lead in the branches of „flexible fixturing“ and „vacuum technology“ as a result of many patented solutions.

The high quality of all Witte products and internal processes is verified according to various certificates on European level.

Qualified staff and a modern machine shop are further guarantees for quality.





NewXS Clamping System2
 ■ Introduction

NewXS 16 Basic components8
 ■ Frames, Bars, Lugs

NewXS 16 Stop and alignment components13
 ■ Centers, Stops

Clamping components16
 ■ Clamps, Top sections, Connectors

NewXS 1626
 ■ Basic Set

Alufix 16 Classic components28
 ■ Compatible with NewXS 16

Alufix 16 Classic connection elements38
 ■ Compatible with NewXS 16

NewXS MiniVac42
 ■ Mini vacuum clamping system

NewXS 1044

Index45

Certification

Witte Barskamp is certified acc. to

- DIN EN ISO 9001 • DIN EN ISO 9100
- QSF-A (Aircraft supplier)



Information:

Weights mentioned in the catalogue are non-committal and approximate, and can deviate considerably i.e. through technical changes.

- We reserve the right to make technical changes.
- Where differences between photos and parts lists exist, the parts lists are decisive.
- Due to fluctuations of copper content in aluminum - alloy colour deviations may occur during anodizing.

All details on our products in this catalogue, especially illustrations, drawings, dimensions and statements on performance are to be regarded as approximate average values. We reserve the right to change design, technical data, dimensions and weights.

The indicated standards, similar technical regulations as well as technical details, descriptions and illustrations are valid at time of printing. Our general trading conditions are valid. Our quotations are decisive.

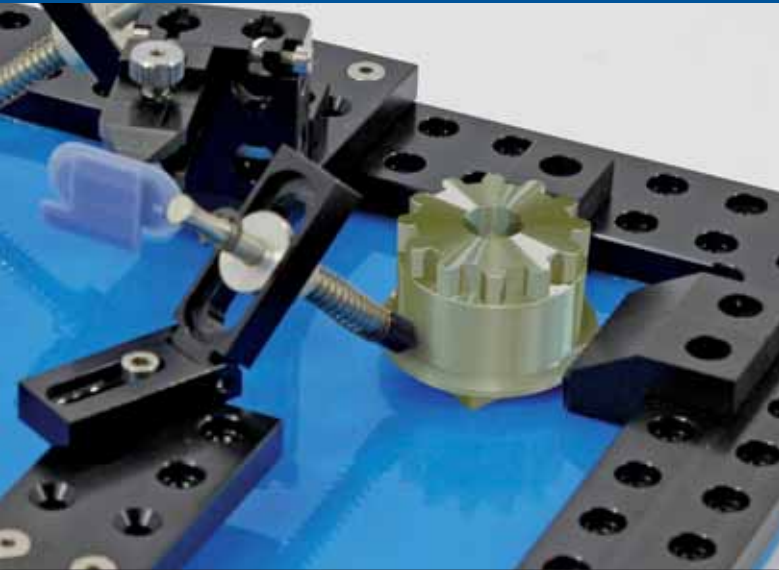

NewXS

Modular fixturing system for optical measuring and checking instruments

NewXS is the consequential continuation of the Witte modular philosophy established worldwide. All elements follow the well-known ALUFIX modular system principle and are compatible.

Suitable for profile projectors and digital image processing:

Two system sizes:

XS 16 and XS 10 for small parts

According to modular principle both upgradeable with a variety of Alufix 16 and including a new mini vacuum solution.

Material: High-tensile aluminium alloy, anodized (black or natural)

Fast, accurate set up and adaptable to new tasks.

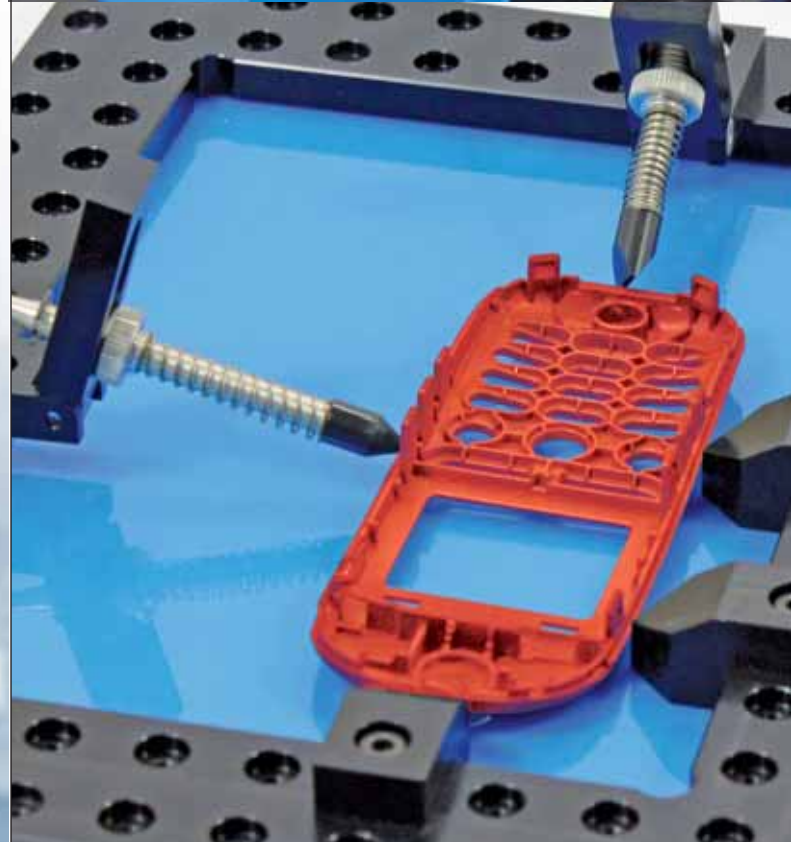
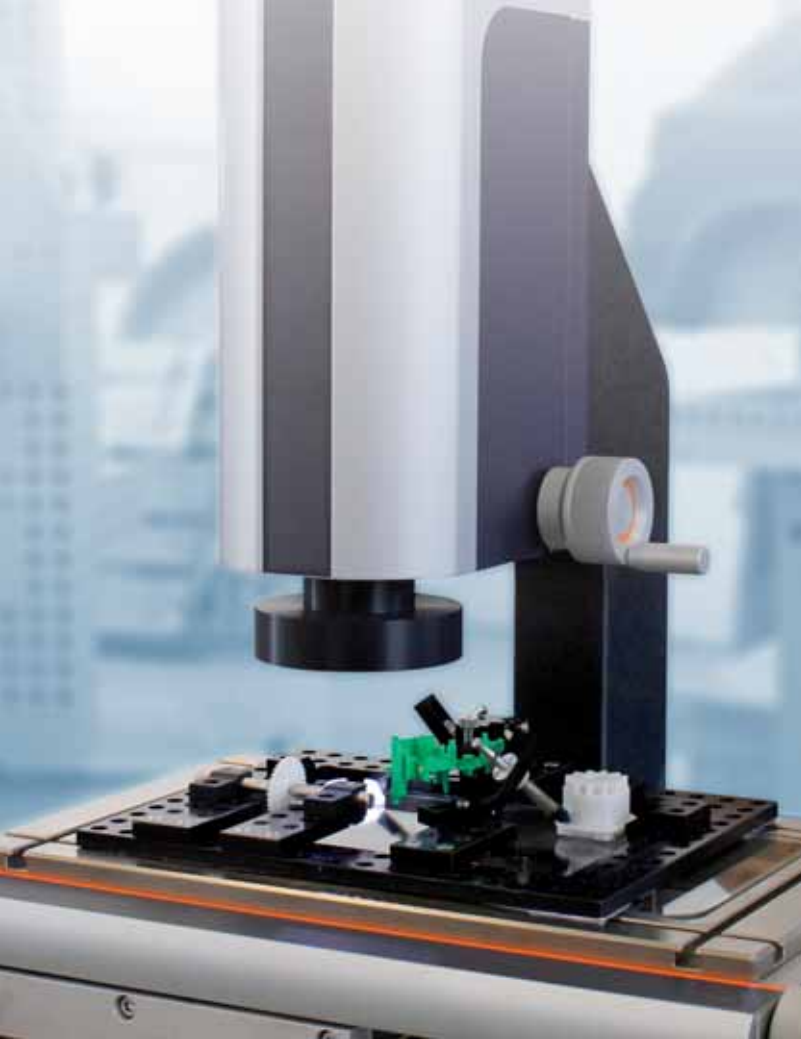

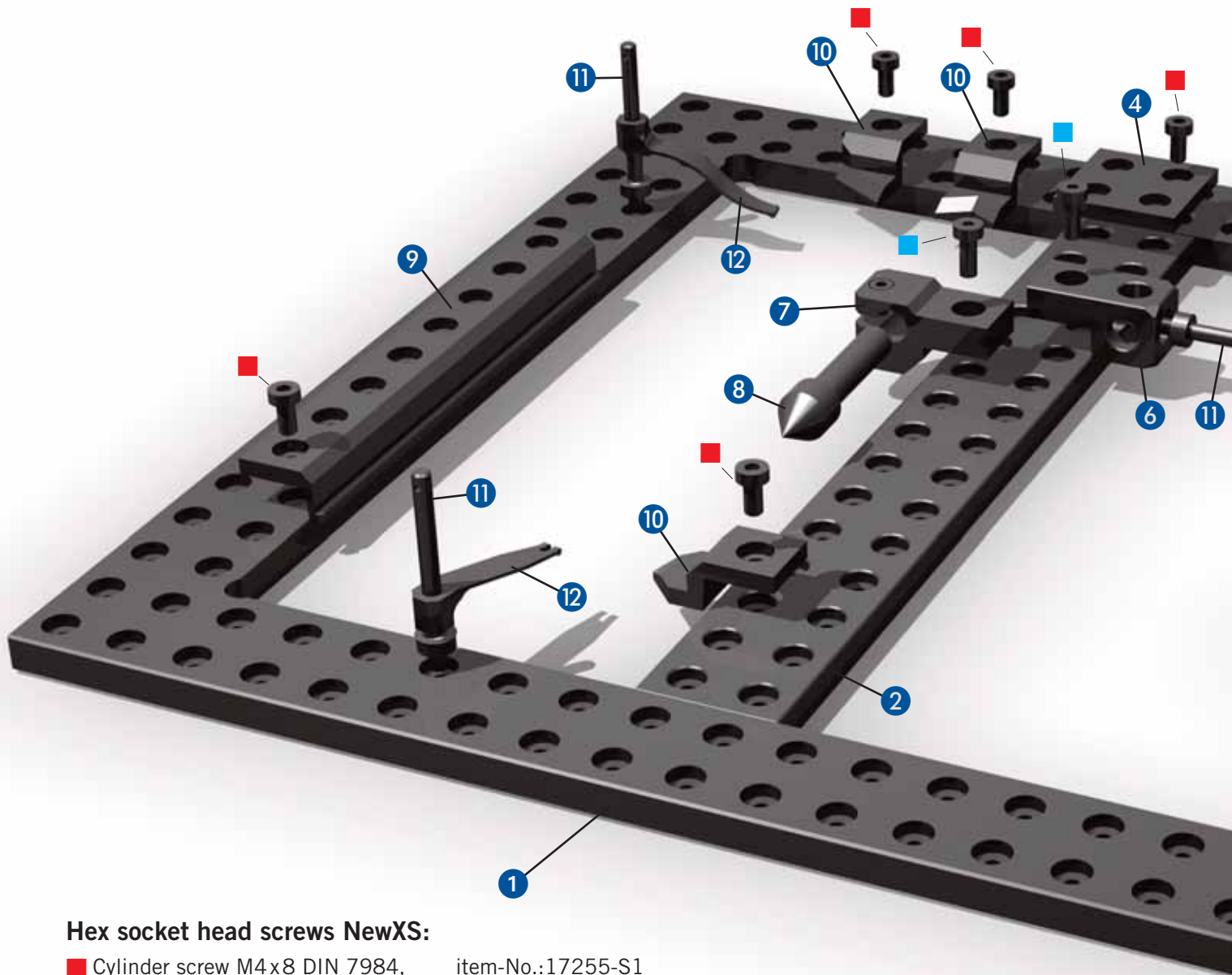

Hex socket head screws NewXS:

- | | |
|--|-------------------|
| ■ Cylinder screw M4x8 DIN 7984, | item-No.:17255-S1 |
| ■ Cylinder screw M4x10 DIN 7984, | item-No.:11546-S1 |
| ■ Cylinder screw M4x12 DIN 7984, | item-No.:16141-S1 |
| ■ Cylinder screw M4x16 DIN 7984, | item-No.:16359-S1 |

Components NewXS Spannsystem

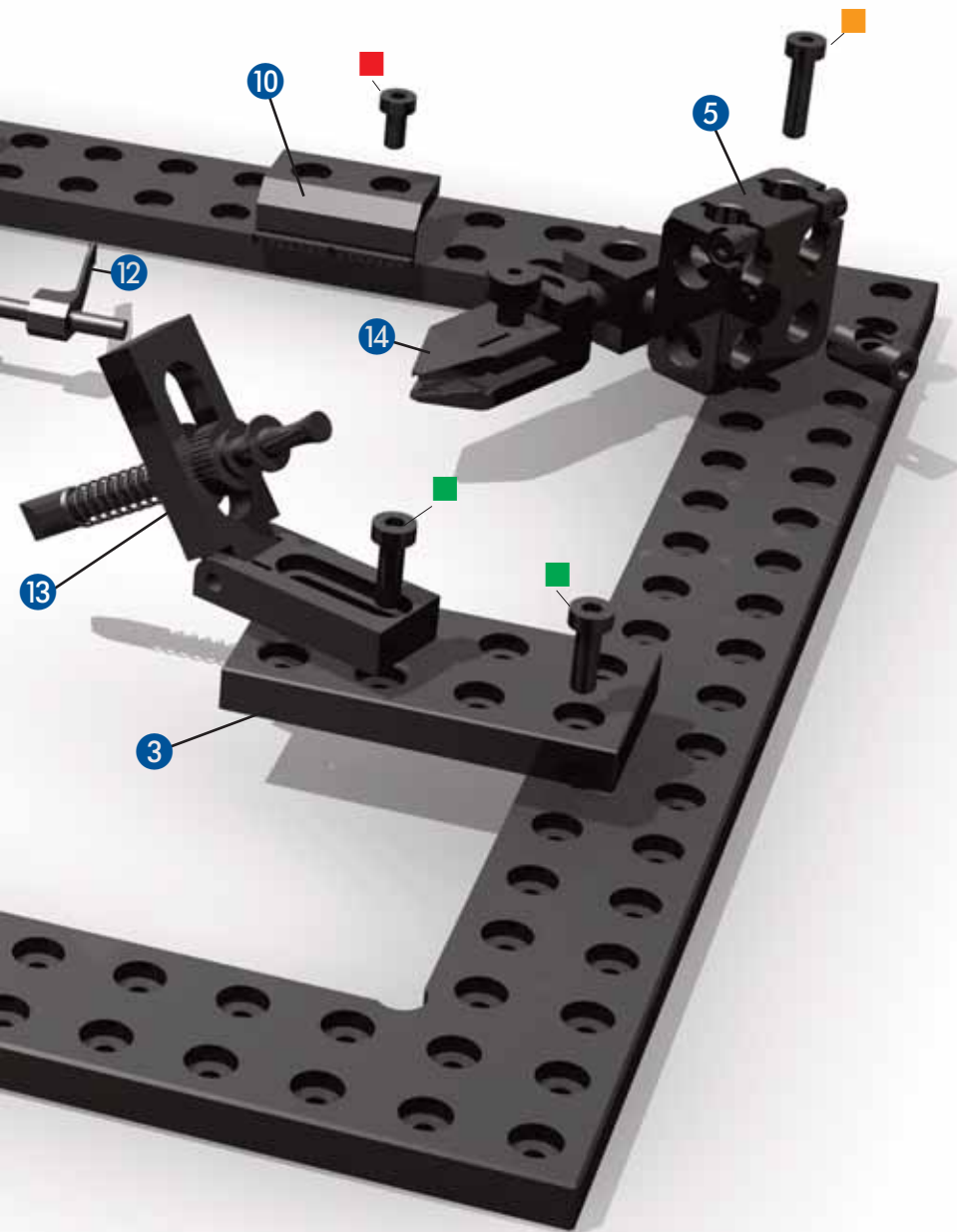

- ① Grid frame
- ② Bars
- ③ Adapter plate
- ④ Connecting lug
- ⑤ Clampholder
- ⑥ Basic bar
- ⑦ Tailstock
- ⑧ Center
- ⑨ Stop bar
- ⑩ Stop
- ⑪ Hold-down column
- ⑫ Hold-down spring
- ⑬ Push rod
- ⑭ Parallel clamp

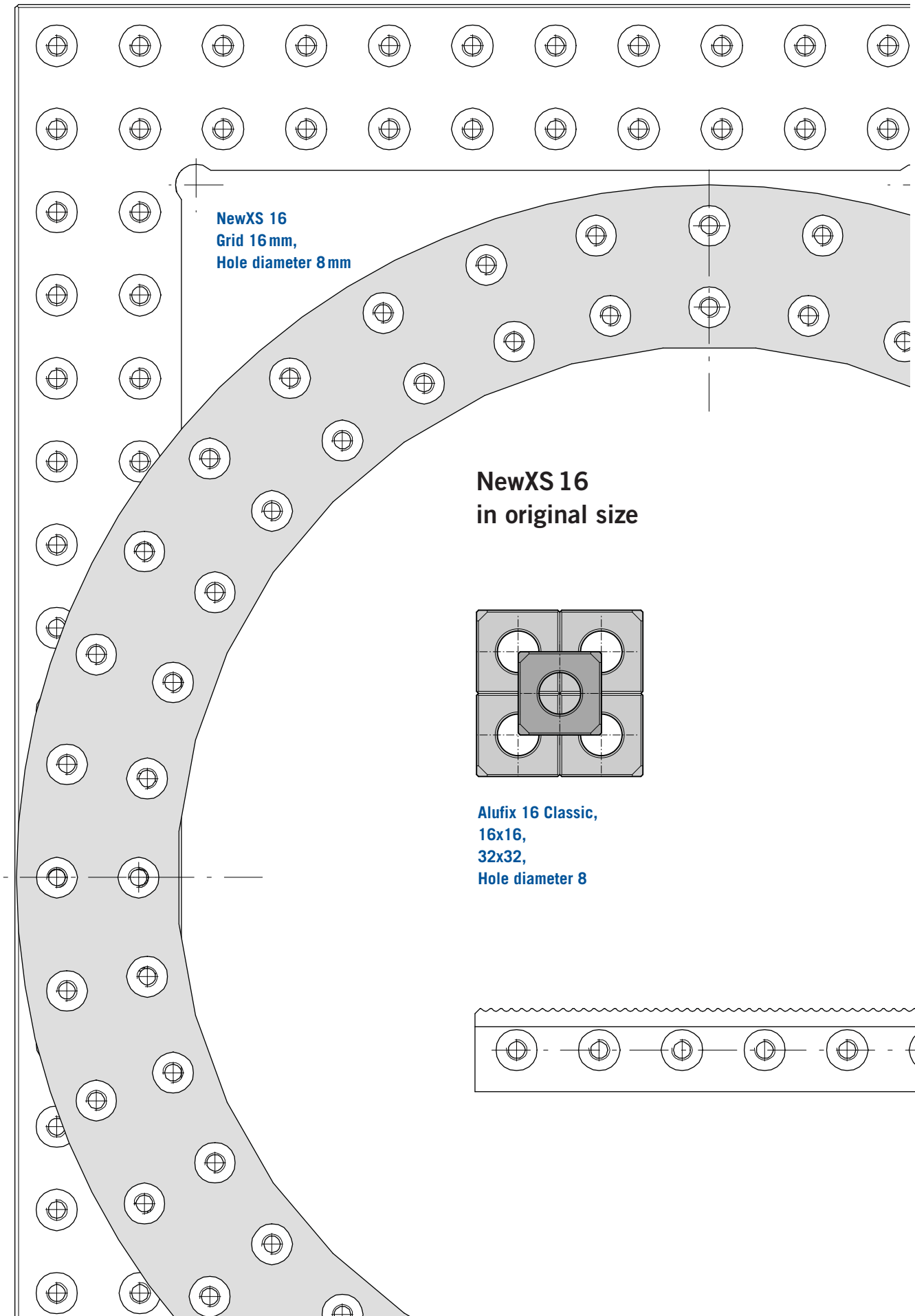

Components

NewXS Fixturing system

NewXS is not only suitable for two dimensional reflected or transmitted light projectors but also for tactile measuring machines and three-dimensional measuring.

2D: Parts normally lie on glass plate of measuring unit, are positioned on the inside of a NewXS frame and clamped against frame or against glass.

3D: The frame serves as a basis for mounting complex contact and support surfaces so that parts can be measured from all sides.



Basic components of NewXS:

Closed or open grid frames in one piece, round, square or rectangular. User defined L-shaped, U-shaped or closed grid frames made of bars.

Special frames adapted to machine surface.

Grid bars for dividing frames into several measuring areas for clamping more than one part at a time, or for positioning adjusting or clamping elements. Adapter plates, stud bars, clamp holders, telescopic columns.

Contact and support components:

Serrated bars, V-pieces, fixed and rotating centers, ball points and tips.



Clamping components:

Hold-down springs, clamps, parallel clamps, horizontal toggle clamps, vacuum suckers, magnetic supports



Alufix 16 supplements:

All Alufix 16 Classic components can be combined with NewXS 16 elements.



Grid frame NewXS 16

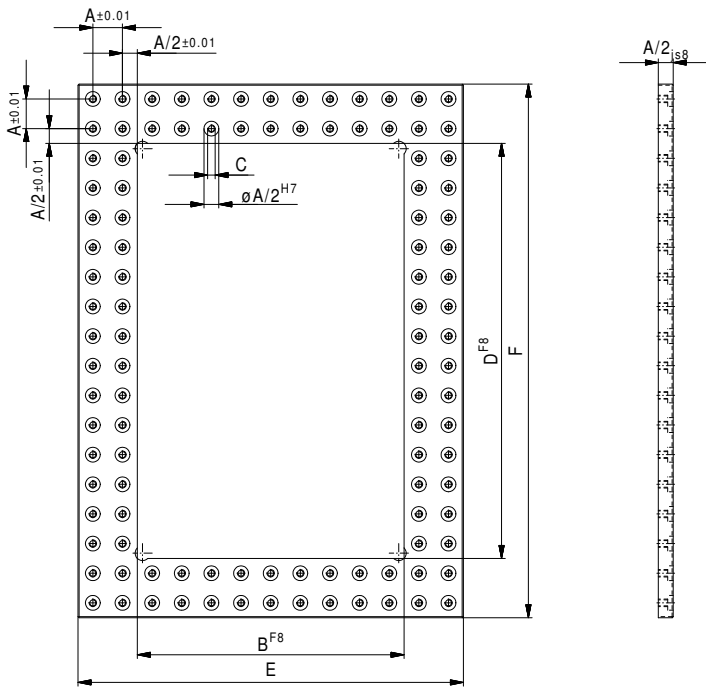

Nr.	A	B	C	D	E	F	
326736-1	16	128	M4	192	192	256	481
324202-1	16	144	M4	208	208	272	521
326737-1	16	224	M4	272	288	336	702
326738-1	16	240	M4	288	304	352	742



Grid ring NewXS 16

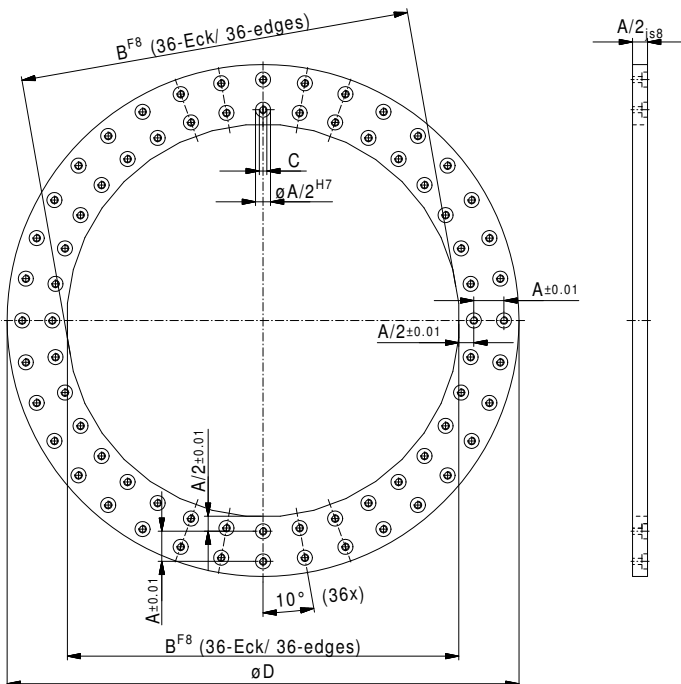

Nr.	A	B	C	D	
326734-1	16	208	M 4	272	484



Stop with clamp NewXS 16

For grid plates XS

Nr.	A	B	C	D	g
95470-1	6	30	61	8	43
281447-1	6	30	175	108	

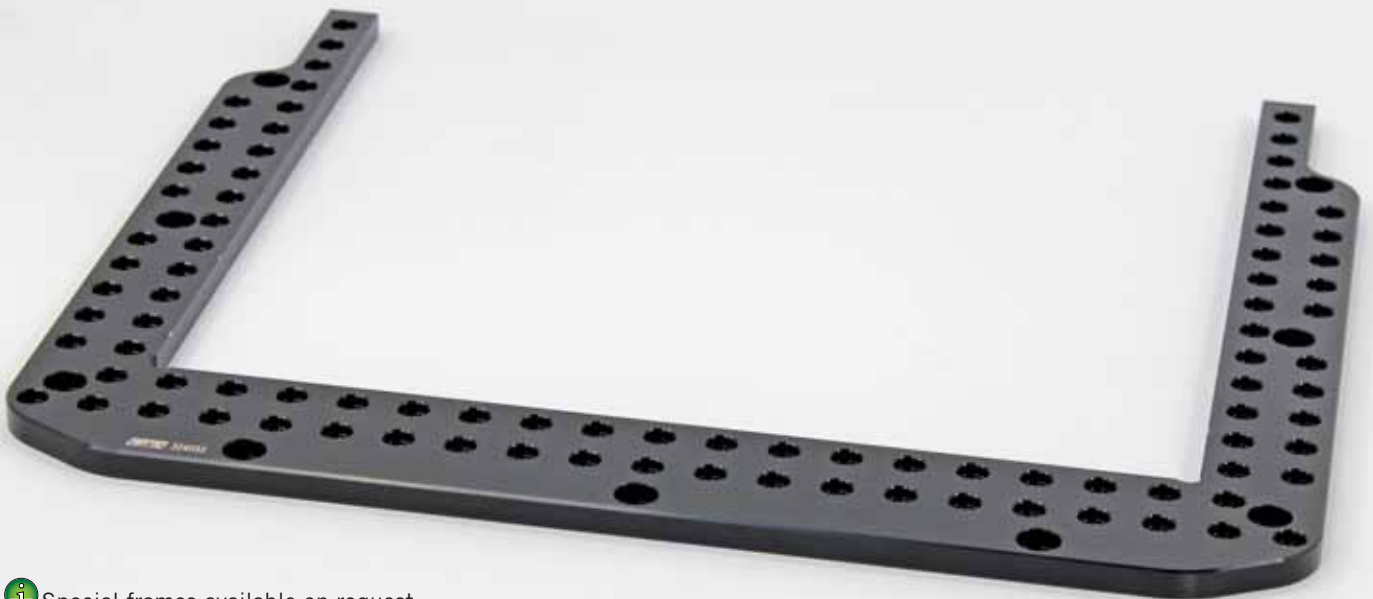
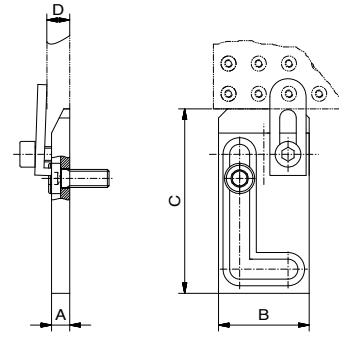

Special frames available on request



NewXS components can be anodized in different colours. Black (with suffix -1) is standard. Anodized natural is also available. Other colours on request.

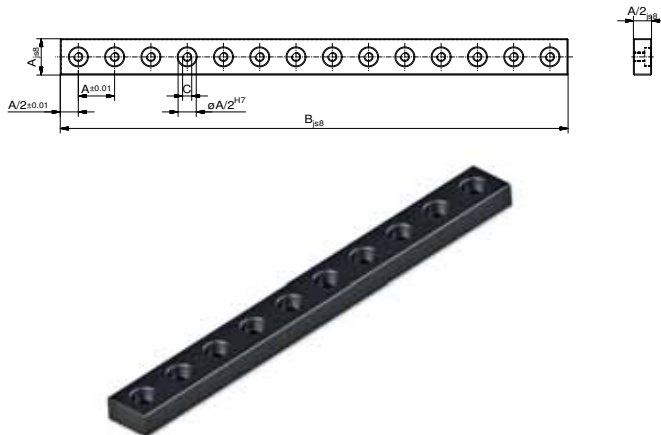

Bar NewXS 16

One row

Nr.	A	B	C	g
327749-1	16	48	M4	15
327750-1	16	64	M4	20
327726-1	16	80	M4	25
327727-1	16	96	M4	30
327728-1	16	112	M4	35
327729-1	16	128	M4	40
327730-1	16	144	M4	45
326725-1	16	160	M4	50
327741-1	16	176	M4	55
326726-1	16	192	M4	60
326727-1	16	208	M4	65
326728-1	16	224	M4	70
326729-1	16	240	M4	75
327785-1	16	256	M4	80

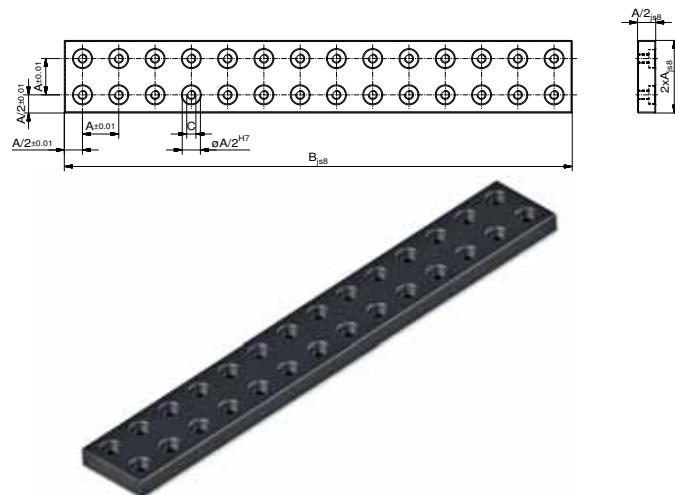

Bar NewXS 16

Two row

Nr.	A	B	C	g
327751-1	16	48	M4	42
327752-1	16	64	M4	56
327722-1	16	80	M4	70
327723-1	16	96	M4	84
327724-1	16	112	M4	98
326858-1	16	128	M4	112
327725-1	16	144	M4	126
326719-1	16	160	M4	140
327718-1	16	176	M4	154
326720-1	16	192	M4	168
326721-1	16	208	M4	182
326722-1	16	224	M4	196
326723-1	16	240	M4	210
326724-1	16	256	M4	224

Adapter plate NewXS 16

Two row

Nr.	A	B	C	
324205-1	16	64	M4	39

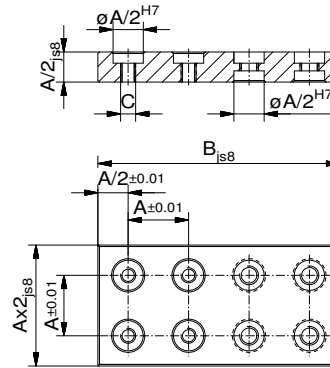

Connecting lug NewXS 16

One row

Nr.	A	B	C	D	
326731-1	16	16	32	4	5
326732-1	16	16	64	4	10

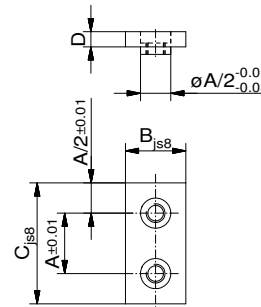

Connecting lug NewXS 16

Two row

Nr.	A	B	C	D	
324203-1	16	32	32	4	10

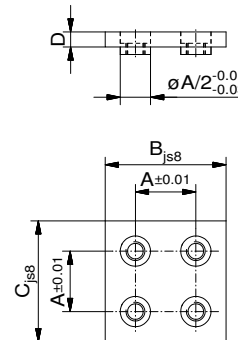

Angle connecting lug NewXS 16

Nr.	A	B	C	D	
326796-1	16	48	48	4	13
326795-1	16	64	64	4	18

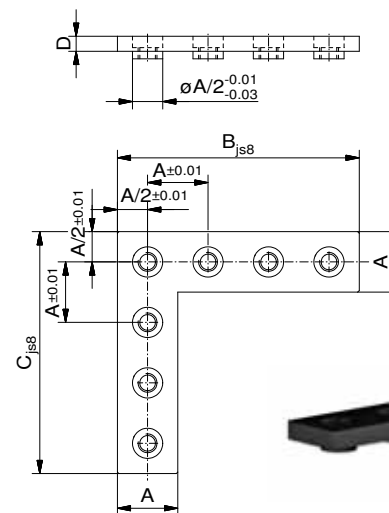

NewXS components can be anodized in different colours. Black (with suffix -1) is standard. Anodized natural is also available. Other colours on request.

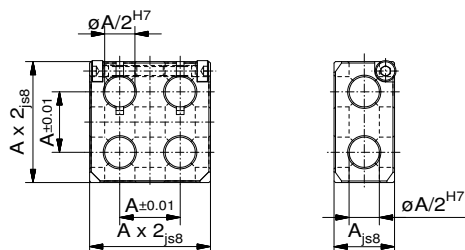

Clampholder NewXS 16

Two row

Nr.	A			
285042-1	16			80

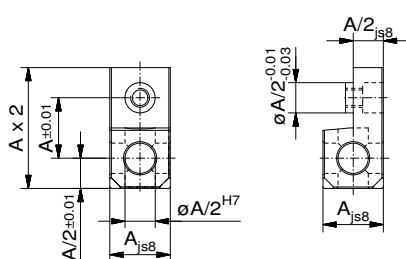

Basic bar NewXS 16

Nr.	A			
324209-1	16			11

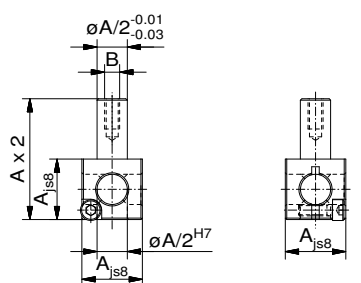

Clampholder NewXS 16

with stud

Nr.	A	B		
285043-1	16	M4		8



Tailstock NewXS 16

Nr.	A	B	C	g
285044-1	16	18	34	14

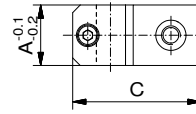
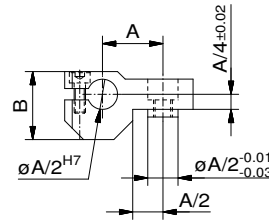

Center NewXS 16

fixed

Nr.	A	B	C	g
326748-1	8	M4	48	6

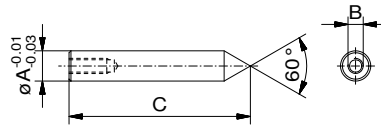

Center NewXS 16

rotating

Nr.	A	B	C	D	E	g
284583-1	8	50	12	18	M4	13

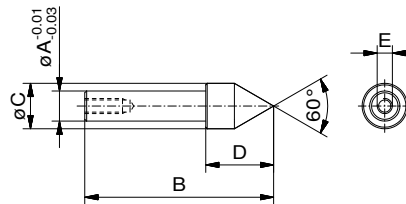

Center NewXS 16

rotating, spring loaded

Nr.	A	B	C	D	E min.	E max.	F	g
284584-1	8	50	12	24	21	26	M4	18

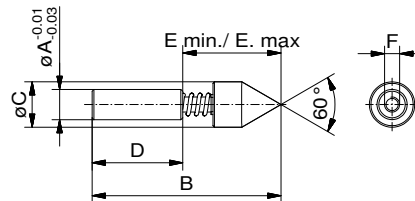

i NewXS components can be anodized in different colours. Black (with suffix -1) is standard. Anodized natural is also available. Other colours on request.

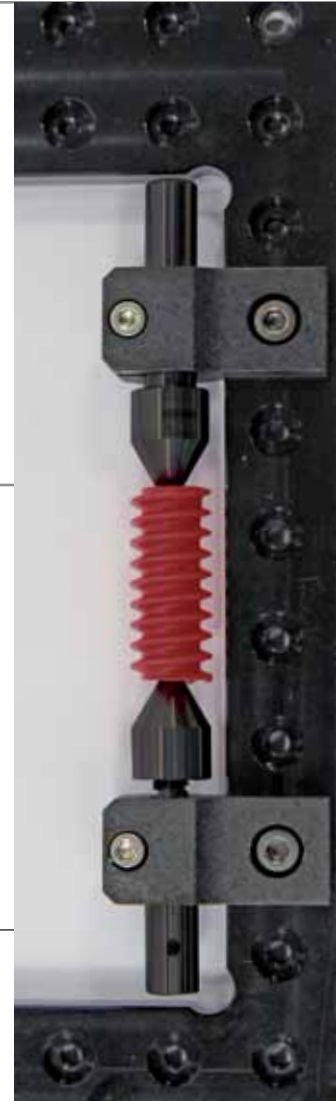

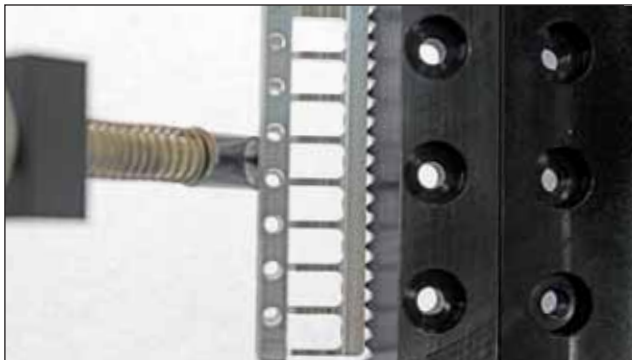
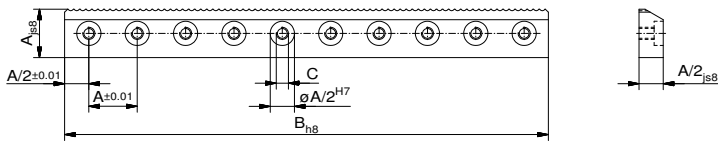

Serrated bar NewXS 16

One row

Nr.	A	B	C	
326753-1	16	160	M 4	45
326754-1	16	192	M 4	54
326755-1	16	208	M 4	59
326756-1	16	224	M 4	63
326757-1	16	240	M 4	68

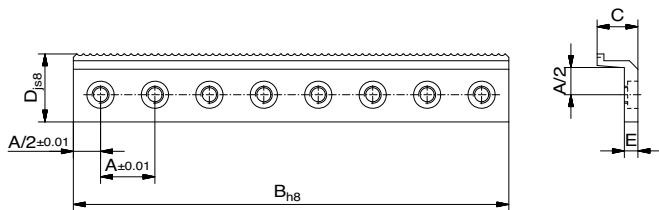

Stop bar NewXS 16

One row, serrated

Nr.	A	B	C	D	E	
326790-1	16	128	12	20	4	26
326791-1	16	144	12	20	4	29
326792-1	16	160	12	20	4	32
326793-1	16	224	12	20	4	45
326794-1	16	240	12	20	4	49

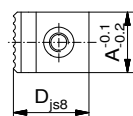
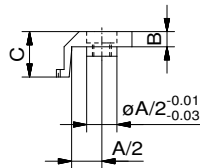

Stop NewXS 16

serrated

Nr.	A	B	C	D	
324206-1	16	4	12	20	6



Stop NewXS 16

pointed

Nr.	A	B	C	g
326741-1	16	4	12	9

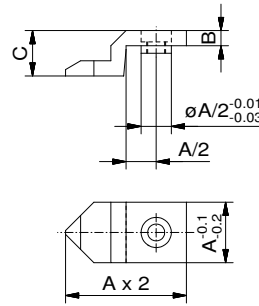

Stop NewXS 16

Prismatic

Nr.	A	B	C	g
326751-1	16	4	12	9

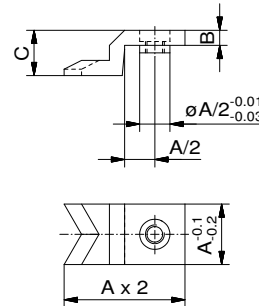

Stop NewXS 16

angled

Nr.	A	B	C	Type	g
324204-1	12	4	12,0	left	8
324318-1	12	4	12,0	right	8

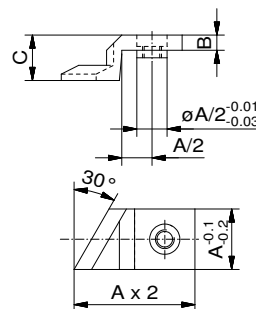

All NewXS stops have a pull-off thread M5

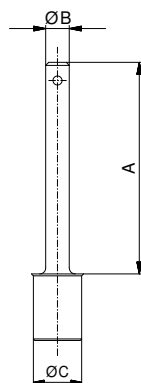

Hold-down column

self-locking

Nr.	A	B	C	D	g
20338-1	35	3,9	8	46	3
22259-1	55	5,9	8	66	5

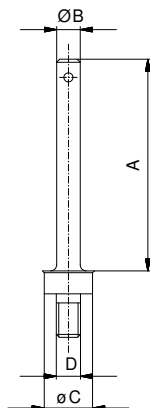

Hold-down column

with thread

Nr.	A	B	C	D	E	g
20339-1	35	3,9	8	M4	46	3
22262-1	55	5,9	8	M4	66	5

for connection using crosspiece (p. 38)

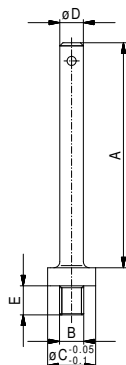

Hold-down column

with shortened thread

Nr.	A	B	C	D	E	g
327460-1	37,2	M4	8	3,9	4,8	3

for connection using crosspiece (p. 38)



Hold down column with thread mounted using crosspiece nut

Hold-down spring

self-locking on hold-down column

Nr.	A	B	C	
20244-1	4	36	7,5	1

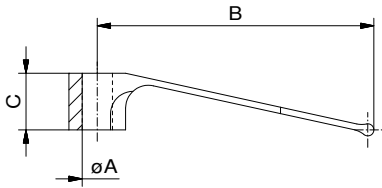

Hold-down spring

in black polymer,
self-locking on hold-down column

Nr.	A	B	C	
326971	4	36	7,5	1



Hold-down spring

for low clamping

Nr.	A	B	C	
34634-1	4	36,5	23,5	2
34764-1	6	36,5	23,5	1

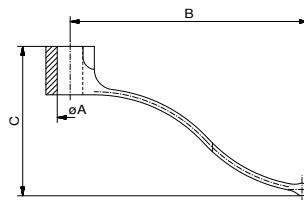

Hold-down spring

forked

Nr.	A	B	C	D	E	F	G	
324211-1	$\varnothing 4$	36,6	7,5	8,3	7,5	1,5	4	1

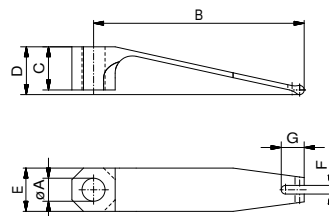

NewXS components can be anodized in different colours. Black (with suffix -1) is standard. Anodized natural is also available. Other colours on request.

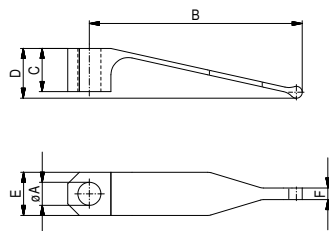

Hold-down spring
tapered

Nr.	A	B	C	D	E	F	G	g
326970-1	ø4	37	7,5	8,7	7,5	2	1	

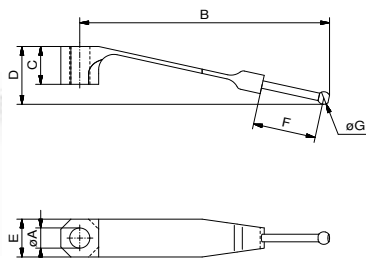

Hold-down spring
with ball point

Nr.	A	B	C	D	E	F	G	g
284708-1	ø4	49,5	7,5	11,5	7,5	12,5	ø2,5	2

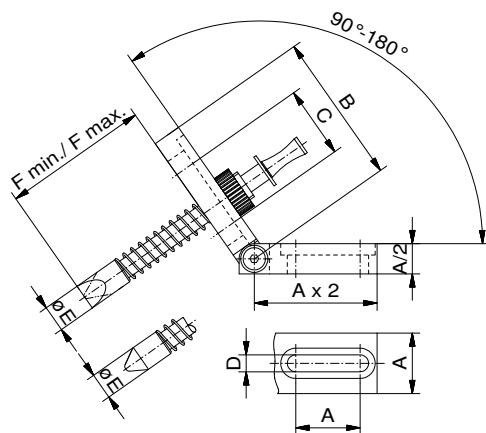

Push rod NewXS 16
spring loaded

Nr.	A	B	C	D	E	F min.	F max.	g
284477-1	16	40	19	4,5	ø7	25	50	23



Parallel clamp NewXS 16

with exchangeable jaws

Nr.	A	B	C	D	E min.	E max.	g
284476-1	16	54	M4	16	0	8	20

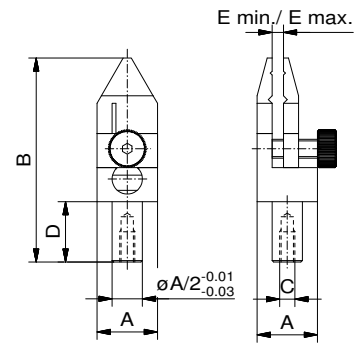

Exchangeable jaws also available in other versions on request



A push rod enables positioning from an angle

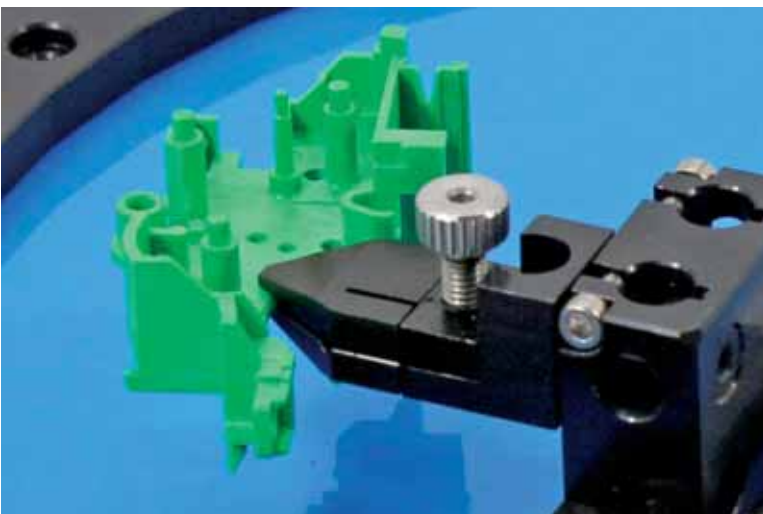

Parallel clamp in combination with clamp holder (p 12)



NewXS components can be anodized in different colours. Black (with suffix -1) is standard. Anodized natural is also available. Other colours on request.

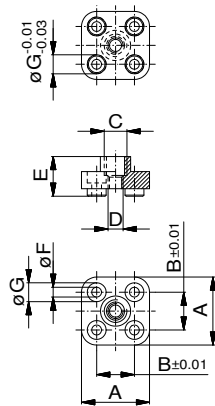

Foot XS 16

Adapter with thread

Nr.	A	B	C	D	E	F	G	
335372-1	24	16	M6	M4	11	4,6	7	3

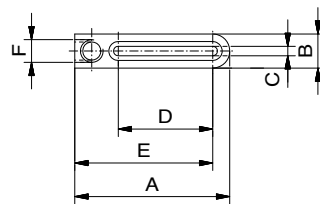

Adjustable fish-tongue

for positioning independent of grid

Nr.	A	B	C	D	E	F	
32432-1	41	9	2,5	25	36,5	M6	10

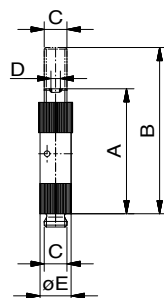

Telescopic unit

with thread

Nr.	A	B	C	D	E	
85839-1	33	44	M6	M2,5	8	5
85444-1	63	99	M6	M2,5	8	10
94806-1	33	48	M6	M2,5	8	5

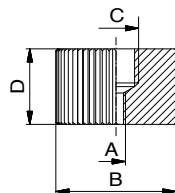

Reducer female/female

M6/M2,5

Nr.	A	B	C	D	
327928-1	M2,5	12	M6	10	3

Supporter

spring loaded

Nr.	A	B	C	D	
81585-1	32,5	48	16	M12X0,5	20

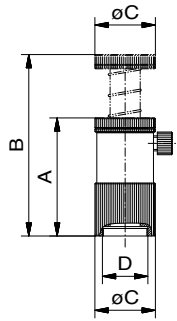

Pincers

small and large

Nr.	A	B	C	D	E	F	
85423-1	46,8	16,9	8	9,3	M6	7	5
85443-1	85	22,2	8	17,5	M6	13	10

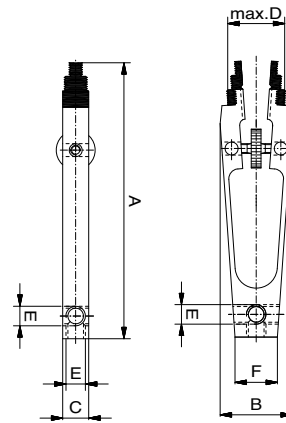

Center

Nr.	A	B	C	D	
23638-1	M12 x 0,5	16	27,5	8	10
54031-1	M12 x 0,5	16	13,75	22	10

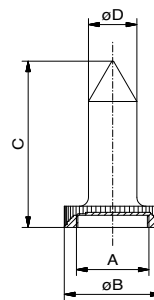

Center

with ball

Nr.	A	B	C	D	E	
85676-1	M12 x 0,5	16	28,5	ø8	ø3	4

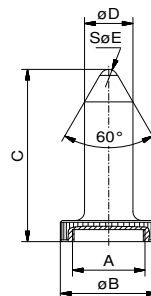

NewXS components can be anodized in different colours. Black (with suffix -1) is standard. Anodized natural is also available. Other colours on request.

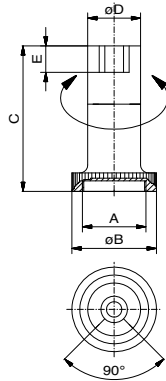

Stop and support

90°

Nr.	A	B	C	D	E	g
93157-1	M12x0,5	16	27,5	10	5	10

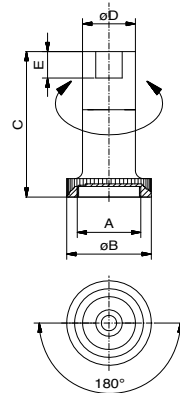

Stop and support

180°

Nr.	A	B	C	D	E	g
93158-1	M12x0,5	16	27,5	10	5	10

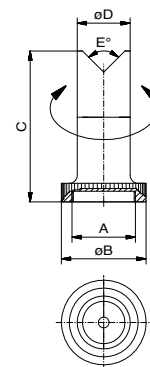

V-piece

Nr.	A	B	C	D	E	g
93159-1	M12x0,5	16	27,5	10	90	10

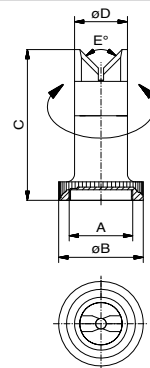

Knife-V

Nr.	A	B	C	D	E	g
93160-1	M12x0,5	16	27,5	10	90	10

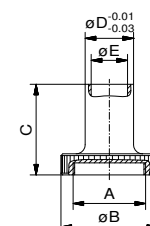

Magnetic Holder

Nr.	A	B	C	D	E	g
95177-1	M12x0,5	$\phi 16$	15	$\phi 10$	$\phi 6$	60
95176-1	M12x0,5	$\phi 16$	22,5	$\phi 10$	$\phi 6$	100

Swivel arm

with joint

Nr.	A	B	C	D	max. load	
85411	130	70	M6	M6	30 N	135

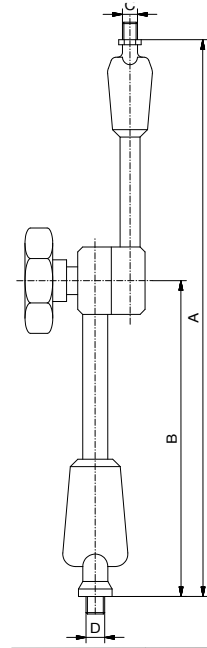
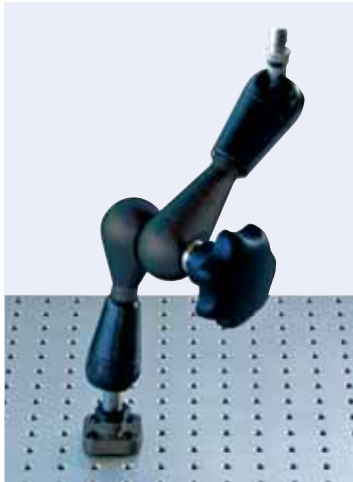

Collet chuck XS 16

Nr.	A	B	C	D	
32440-1	M6	31	9,8	11,8	10

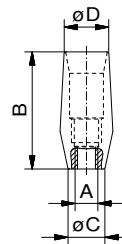

Collet XS 16

Nr.	A	B	C	D	E	F	
32453-1	1,0	11	8	28	5	14,5	3
32463-1	1,5	11	8	28	5	14,5	3
32464-1	2,0	11	8	28	5	14,5	3
32465-1	2,5	11	8	28	5	14,5	3
32466-1	3,0	11	8	28	5	14,5	3
32467-1	3,5	11	8	28	5	14,5	3
32468-1	4,0	11	8	28	5	14,5	3
32469-1	4,5	11	8	28	5	14,5	3
32470-1	5,0	11	8	28	5	14,5	3
32471-1	5,5	11	8	28	5	14,5	3
32472-1	6,0	11	8	28	5	14,5	3

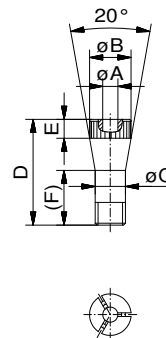

NewXS components can be anodized in different colours. Black (with suffix -1) is standard. Anodized natural is also available. Other colours on request.

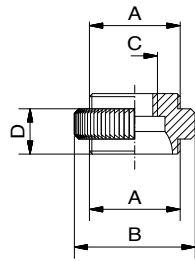

Adapter for Ball joint

Nr.	A	B	C	D	
32524-1	M12x0,5	16	M6	6	2

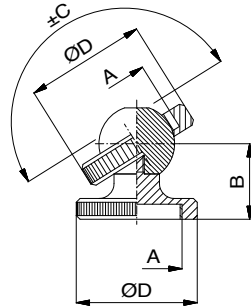

Ball joint

Nr.	A	B	C	D	
81588-1	M12x0,5	10	55°	16	4

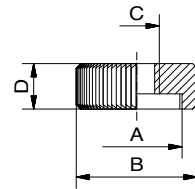

Reducer

Nr.	A	B	C	D	
32525-1	M12x0,5	16	M6	6	2

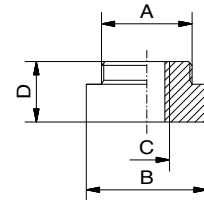

Reducer

with collar, also for swivel arm

Nr.	A	B	C	D	
32526-1	M12x0,5	16	M6	8	3

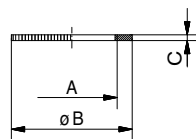

Clamping ring

for keyless chuck

Nr.	A	B	C	
53928-1	M12x0,5	16	1,5	2

Fixing disc

with stud

Nr.	A	B	C	D	
81587-1	10	M12x0,5	M4	8	2

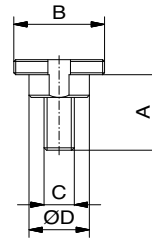

Fixing disc

without stud

Nr.	A	B	C	
81589-1	8	M12x0,5	M4	2

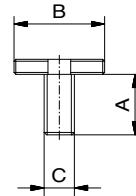

Adapter disc

Nr.	A	B	C	D	E	F	
55875-1	8	3	14	M6	M12x0,5	16	3

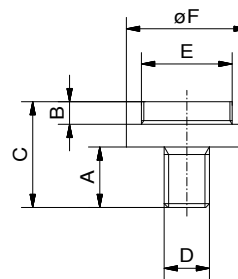

Hex socket head screw

DIN 7984

Nr.	A	B	DIN	WAF	
17255-S1	8	M4	7984	2,5	1
11546-S1	10	M4	7984	2,5	1,5
16141-S1	12	M4	7984	2,5	1,5
16359-S1	16	M4	7984	2,5	1,5

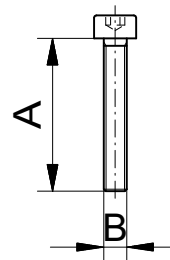

Tool

Nr.	WAF	
17374	2,5	240



NewXS components can be anodized in different colours. Black (with suffix -1) is standard. Anodized natural is also available. Other colours on request.

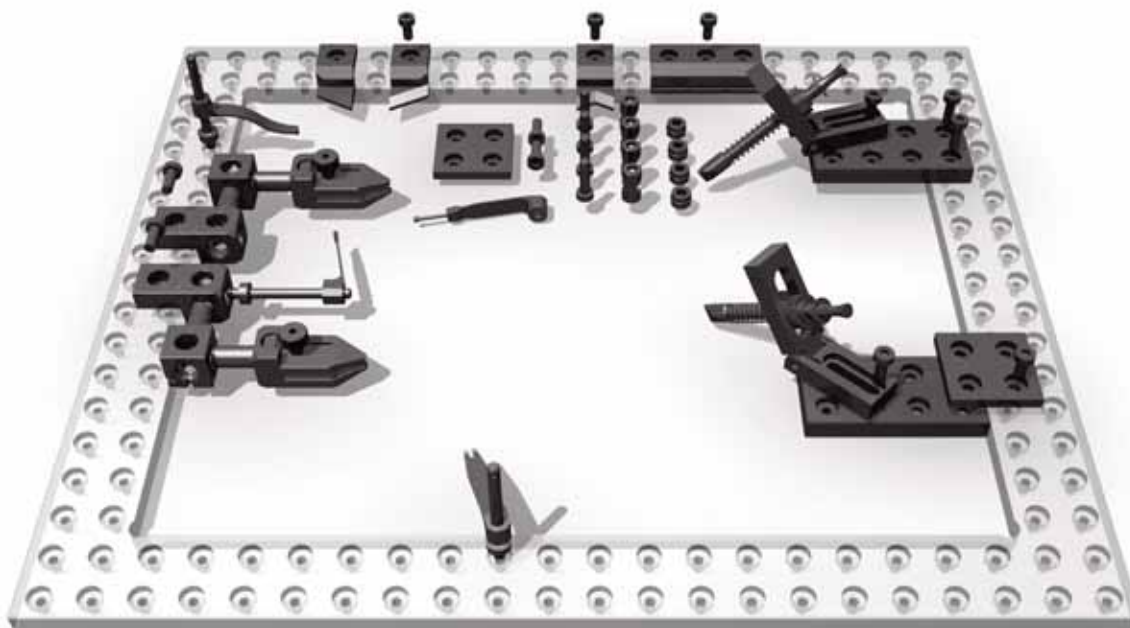

#284421-1 Basic Kit Set up components

NewXS 16, (42-pcs), 2,7 kg

 The grid frame is not included in the set. Frames and bars suitable for your specific application are shown from page 8

Nr.	pcs	Name
324205-1	2	Adapter plate B=32mm L=64mm
324203-1	2	Connecting lug B=32mm
324204-1	1	Stop angled left
324318-1	1	Stop angled right
324209-1	2	Basic bar XS 16
284476-1	2	Parallel clamp XS 16
284477-1	2	Push rod
324208-1	2	Clamp holder B=16mm L=32mm
324206-1	3	Stop serrated B=16mm
327460-1	3	Hold-down column with thread
34634-1	1	Hold-down spring for low clamping
20244-1	2	Hold-down spring
284708-1	1	Hold-down spring with ball end
324211-1	1	Hold-down spring with forked end
324216-1	4	Positioning sleeve D=8mm
17255-S1	4	Cylinder head screw M4X8 DIN 7984
11546-S1	4	Cylinder head screw M4x10 DIN 7984
16141-S1	4	Cylinder head screw M4X12 DIN 7984
16359-S1	4	Cylinder head screw M4x16 DIN 912
52891-1	4	Crosspiece Ø4,3/16 AF16
12417	1	Storage case



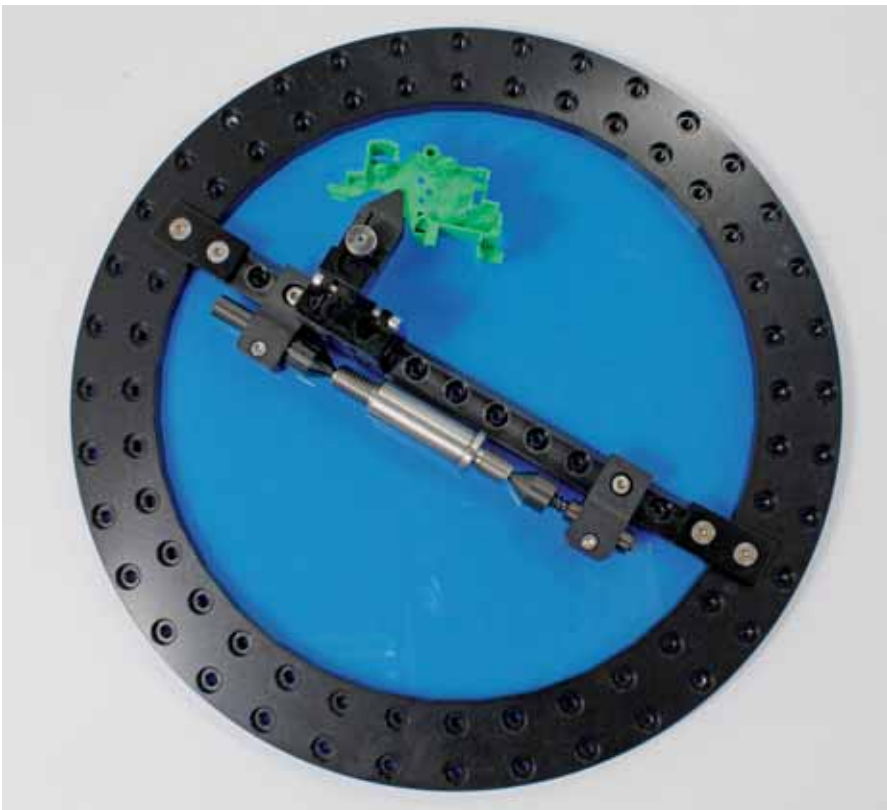
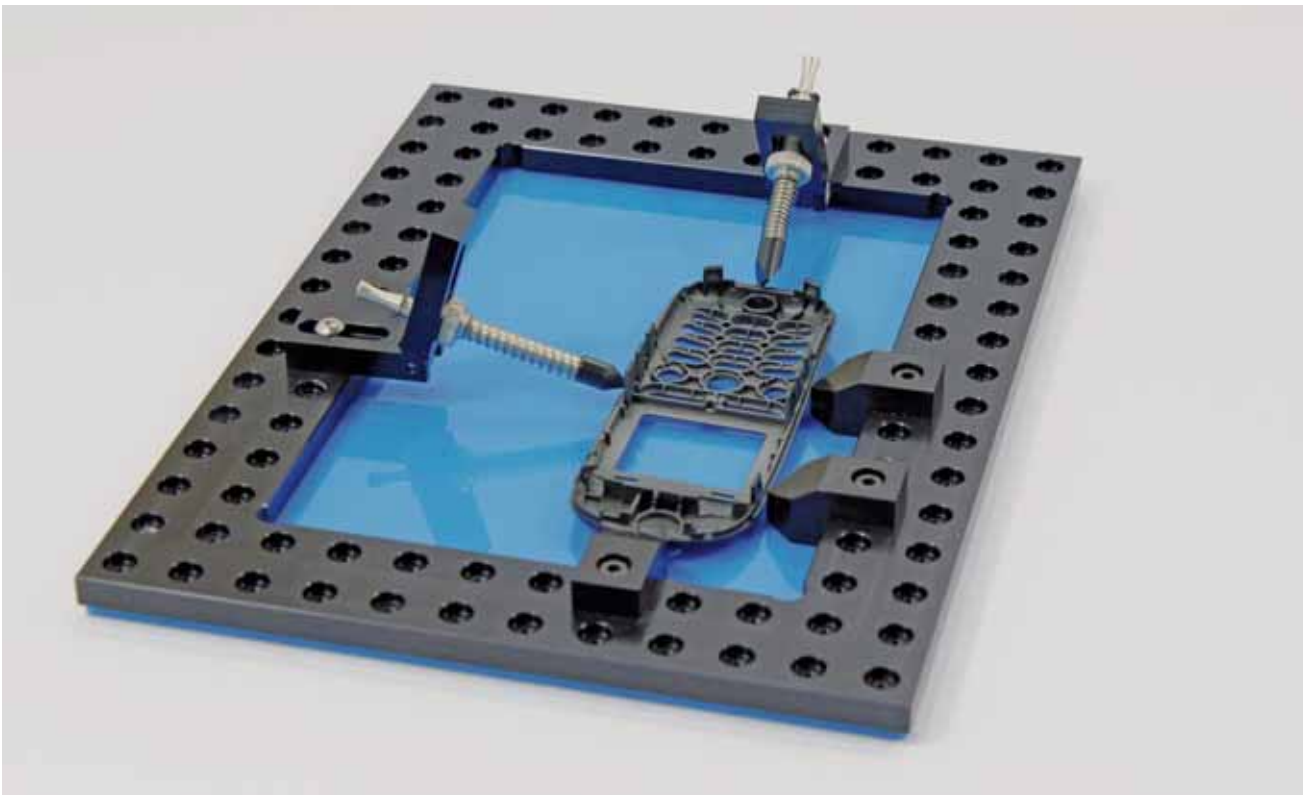

Various applications for filigree parts



i NewXS components can be anodized in different colours. Black (with suffix -1) is standard. Anodized natural is also available. Other colours on request.

Components

ALUFIX 16 CLASSIC

compatible with NewXS 16

Alufix Classic is the worldwide renowned and proven modular clamping and fixturing system for almost all applications in dimensional measuring technology.

Due to the high accuracy and quantity of intelligent elements Alufix sets are also in use as assembly and positioning systems. Right across all business areas ranging from automotive industry through aerospace to biomedical sciences people trust and use Witte Alufix Classic. If you have different materials, your parts vary in size, mass or stability, or you are measuring with tactile or optical equipment, Alufix Classic is the answer!

Due to the variety of components and of course the long experience of Witte Alufix Classic offers a solution for almost every task. Alufix Classic is not only an investment for current requirements but especially for the future, as all elements, according to the real idea of a modular system, are reusable and compatible with other Witte systems and elements.

Profiles in original size

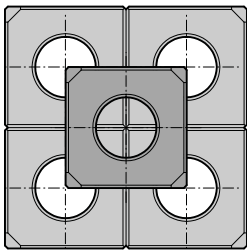

AF 16 full,
16x16,
32x32,
Hole diameter 8

Material:	EN AW 7075 (high tensile aluminium)
Tensile strength:	Min. 480 N/mm ²
Hardness:	Min. 130 HB
Yield strength:	Min. 390 N/mm ²
E Module:	72.000 N/m ²



Base plates

serve as a base for building small to medium size fixtures. They can be connected on all 6 sides using quick or screw connection technology and are extremely flexible for all kinds of applications.



Bars

are suitable for building small to medium size fixtures as a link between base and workpiece contact point. They can be connected on all 6 sides using quick or screw connection technology and are extremely flexible for all kinds of applications.

Struts

serve to increase rigidity in frame type fixtures and for supporting columns. Depending on requirements they are connected at the ends to bars, grid or base plates using quick or screw connectors. The specially designed strut ends allow them to be mounted in two different angles by rotating 180°.



Clamping elements

and clamps also in combination with workpiece contact points



Adjustment elements

enable contact points to be accurately aligned with a workpiece independent of the system grid.

Grid Base Plate ALUFIX 16

Grid (A) 16, hole diameter 8mm

Nr.	A	B	C	D	
20640-1	16	128	256	M4	1.416
20641-1	16	160	320	M4	2.221
20642-1	16	192	256	M4	2.123
20643-1	16	192	384	M4	3.185
20644-1	16	256	320	M4	3.539
20645-1	16	256	384	M4	4.247
20646-1	16	320	320	M4	4.424
20647-1	16	320	640	M4	8.847
20648-1	16	384	384	M4	6.370
20649-1	16	384	512	M4	8.493

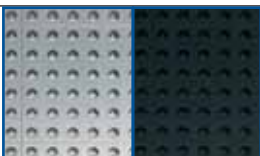
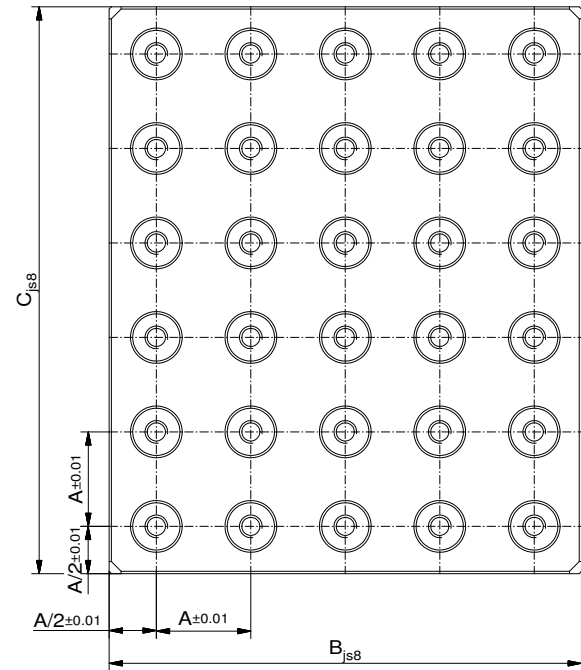
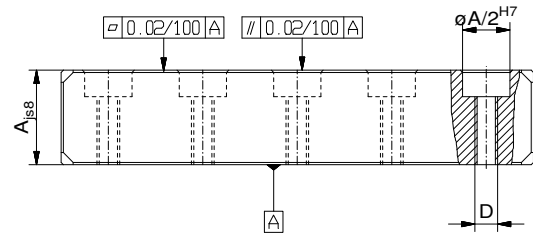

NewXS Base plates can be anodized in different colours. Black (with suffix -1) is standard. Anodized natural is also available. Other colours on request.



Base plate ALUFIX 16

Grid (A) 16, hole diameter 8mm

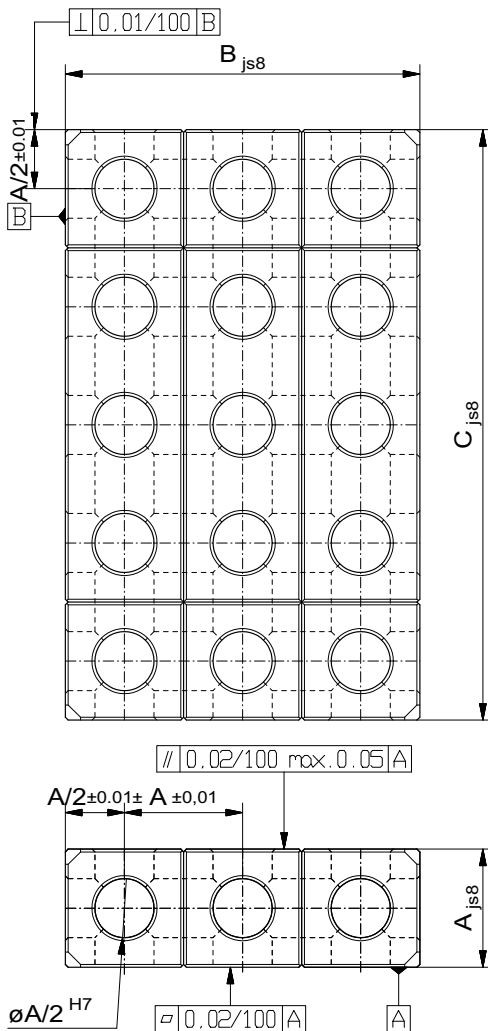

Nr.	A	B	C	g
22093-1	16	32	32	27
22094-1	16	32	48	40
22095-1	16	32	64	53
22096-1	16	32	80	100
22932-1	16	32	96	80
22931-1	16	32	112	93
20652-1	16	32	160	131
20653-1	16	32	320	300
22930-1	16	64	96	160
21566-1	16	64	112	187
22929-1	16	64	128	214
21567-1	16	80	112	234
22928-1	16	80	128	267
21568-1	16	80	144	305
22926-1	16	80	160	335
21569-1	16	96	96	242
21570-1	16	96	112	282
21571-1	16	96	128	325
21572-1	16	96	144	375
21573-1	16	96	160	240
22924-1	16	96	176	447
22907-1	16	96	192	482
21574-1	16	112	240	703
21575-1	16	128	128	431
21576-1	16	128	144	475
21577-1	16	128	256	862
21579-1	16	160	192	804
21578-1	16	160	320	1.400
21580-1	16	192	256	1.298
21581-1	16	192	320	1.611
20112-1	16	240	240	1.510
22097-1	16	320	320	1.350
28076-1	16	384	384	3.812

Full Bar ALUFIX 16

One row bar 16x16, Grid (A)16, hole diameter 8mm

Nr.	B	
21582-1	16	7
21583-1	32	14
21584-1	48	21
21585-1	64	27
21586-1	80	33
20654-1	96	39
20801-1	128	53
20799-1	160	66
21587-1	320	140

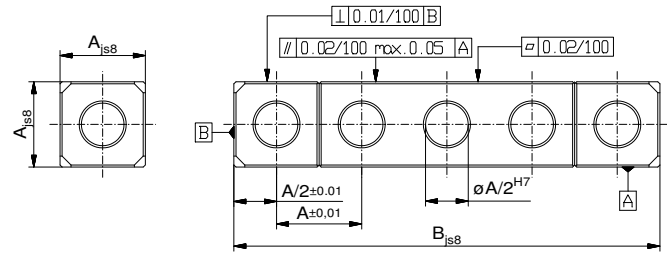

Full Bar ALUFIX 16

Two row bar 32x32, Grid (A)16, hole diameter 8mm

Nr.	B	
21588-1	32	53
21589-1	48	79
21590-1	64	108
21591-1	80	131
23892-1	96	160
20812-1	112	200
20848-1	128	230
20849-1	160	268
21592-1	320	537

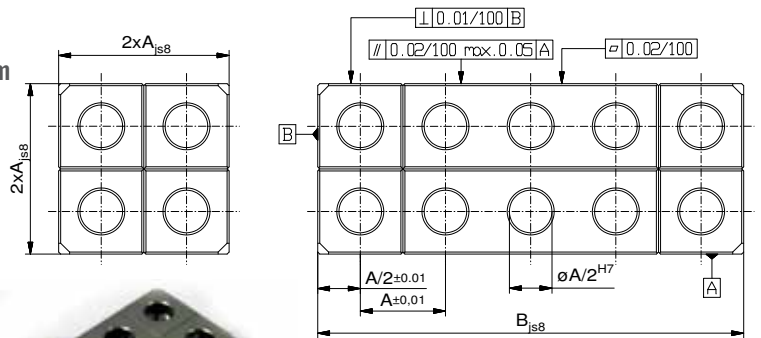

Angle bracket

Alufix Classic, A=16

Nr.	A	
25101-1	1x	10
25102-1	2x	20
25103-1	3x	32

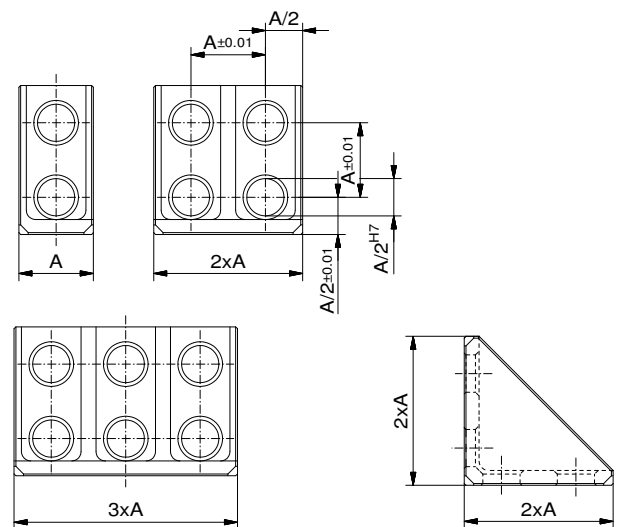

NewXS bars can be anodized in different colours. Black (with suffix -1) is standard. Anodized natural is also available. Other colours on request.

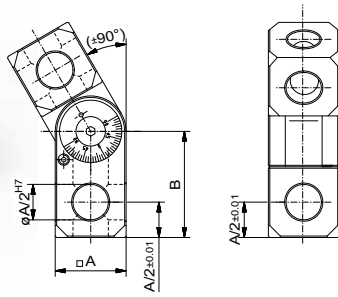

Knuckle

Nr.	A (AF)	B	
81668-1	16	45	28

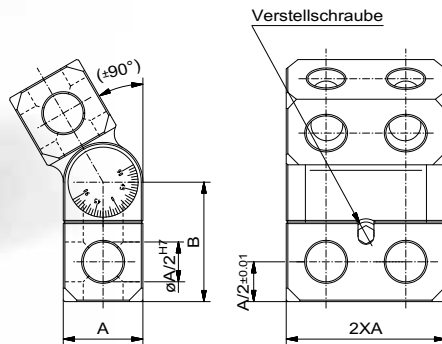

Double knuckle

Nr.	A (AF)	B	
81811-1	16	45	65

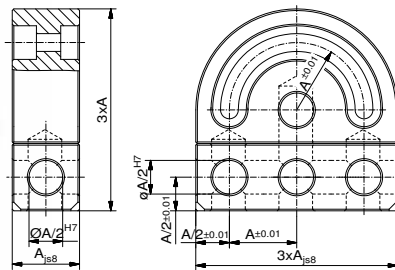

Swivel

Nr.	A (AF)	
24578-1	16	56

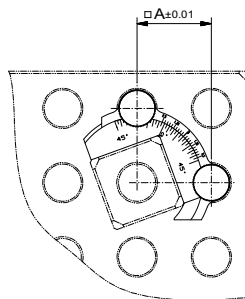

Heel block 45° - 90°

Nr.	A (AF)	
81607	16	4

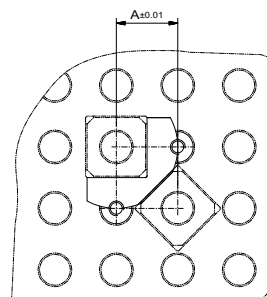

Heel block 45°/ 90°

Nr.	A (AF)	
23667-1	16	3

Roller slide

adjustment using a screw spindle

Nr.	A (AF)	B	max. load	shift	
82453-1	16	M4	20 kg	±9	89

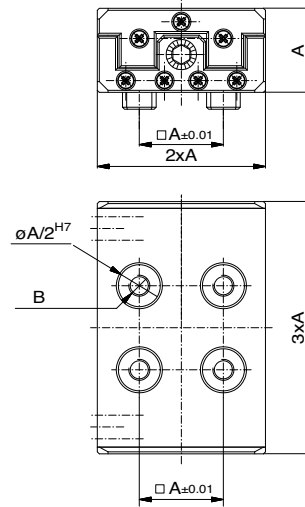

Cross roller slide

adjustment using a screw spindle

Nr.	A (AF)	B	max. load	shift	
82461-1	16	M4	20 kg	±9	178

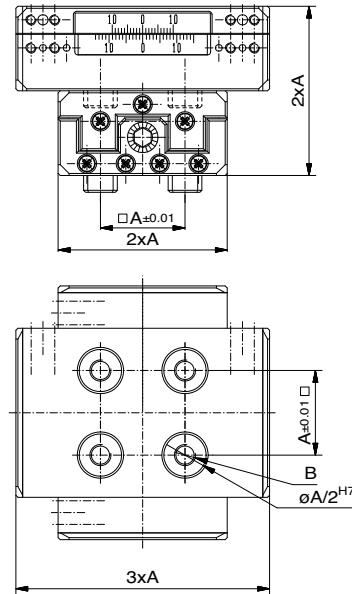

Slide stop

for roller slides

Nr.	A/min	A/max	B	
82411-1	59	77	6,4	98

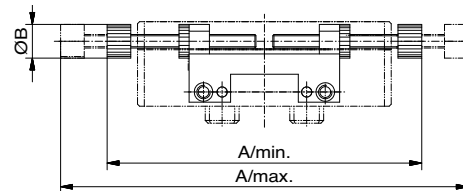

NewXS components can be anodized in different colours. Black (with suffix -1) is standard. Anodized natural is also available. Other colours on request.



Arrange 2 delta blocks
in a V to support round parts

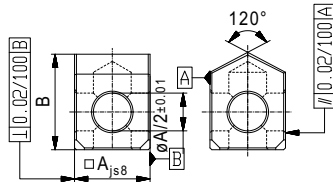

Delta block 120°

Form 1

Nr.	A(AF)	B	
22240-1	16	20	8

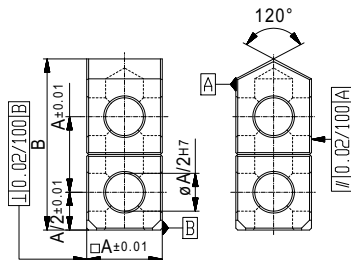

Delta block 120°

Form 2

Nr.	A(AF)	B	
22252-1	16	36	15

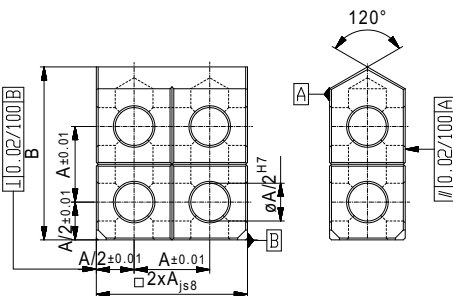

Delta block 120°

Form 3

Nr.	A(AF)	B	
22255-1	16	36	30

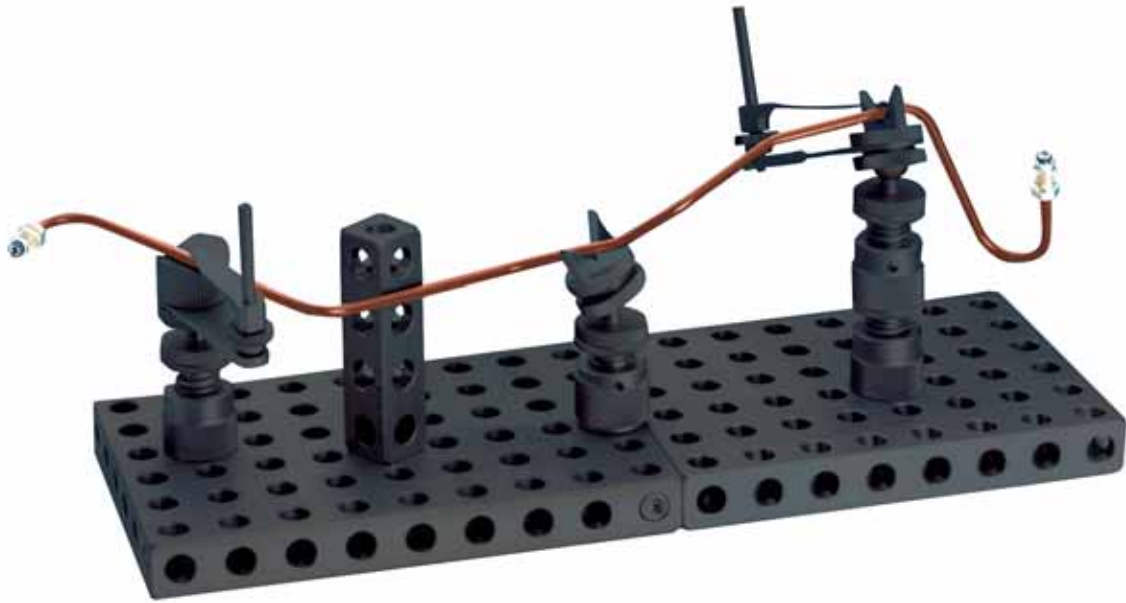

V piece 90° single

Nr.	A	B(AF)	C	D	E	F	g
80923-1	24	16	1	M4	3	8	9

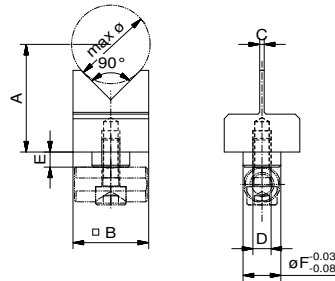

V piece 90° double, V narrow

Nr.	A	B(AF)	C	D	E	F	G	g
80921-1	24	16	1	M4	3	8	7	10

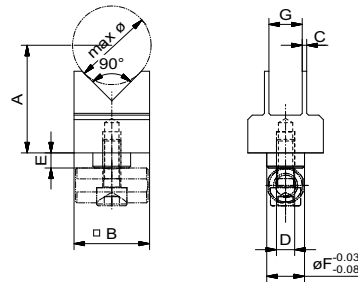

V piece 90° double, V wide

Nr.	A	B(AF)	C	D	E	F	g
80922-1	24	16	1	M4	3	8	10

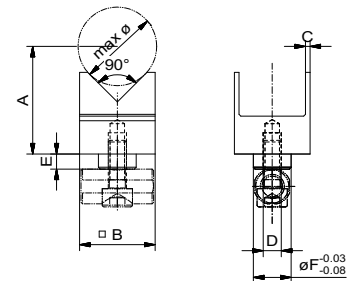

i NewXS components can be anodized in different colours. Black (with suffix -1) is standard. Anodized natural is also available. Other colours on request.

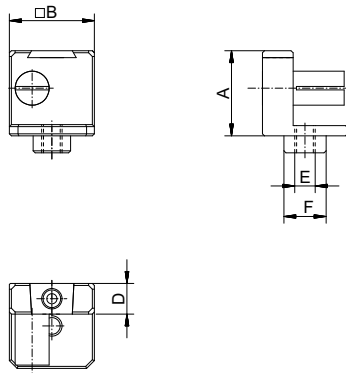

Winder

Nr.	A	B(AF)	D	E	F	
80742-1	16	16	6	M4	8	11

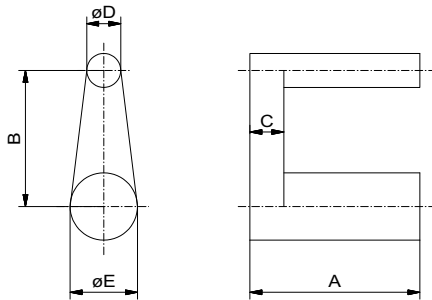

Deflector

Nr.	A	B	C	D	E	
22274-1	19	16	3	4	7,9	4



Winder tape

in plastic, 12 mm wide

Nr.	length (m)
00041	5

Round symmetrical parts quickly and easily positioned on V block for measuring and secured using winder, tape and deflector



Vise ALUFIX 16

Nr	E (AF)	A	B	C	D	E	F	
81784-1	16	80	32	32	40	16	M12x0,5	310

Pins shown in picture not included

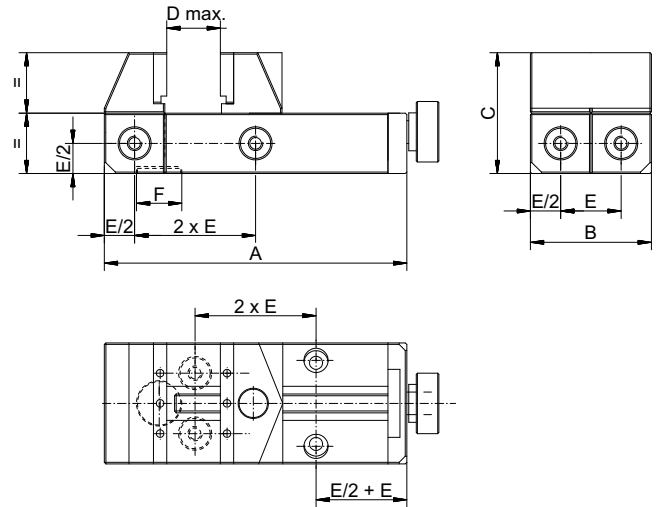
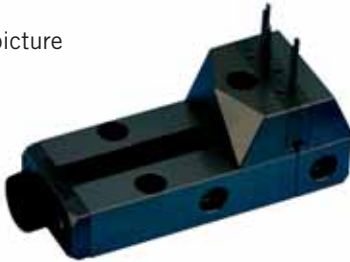

Pin ALUFIX 16

for vise

Nr.	A	B	C	D	E	
24604-1						

3-Jaw Keyless Chuck ALUFIX 16

Nr.	A	B	C	D	
82220-1	50	60	23,3	17,3	95

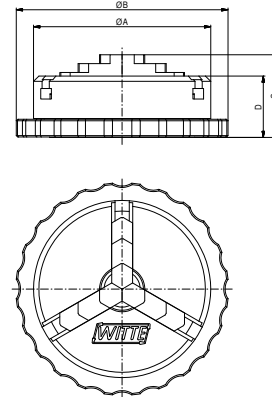

Centerplate ALUFIX 16

for keyless chuck

Nr	A	B	C	D	E	F	G	H	I	
82371-1	75	11	8	5	32	6,6	11	M6	8	100

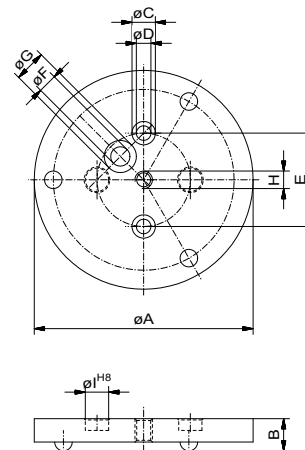

NewXS components can be anodized in different colours. Black (with suffix -1) is standard. Anodized natural is also available. Other colours on request.

For other versions of vises and keyless chucks please see our main catalogue, chapter "clamping elements"

ALUFIX

Connection Elements

A variety of elements allows combination of Alufix components whenever two opposite holes, or a hole and a nub are to be connected. This works also between different system sizes using reducer sleeves.



Quick connection

For fast, constantly changing fixtures we recommend using quick connection elements.

A twin bolt is positioned between Alufix elements to be connected. An excentric slot on the lock slides round and grips the head of a twin bolt resulting in a tight connection.

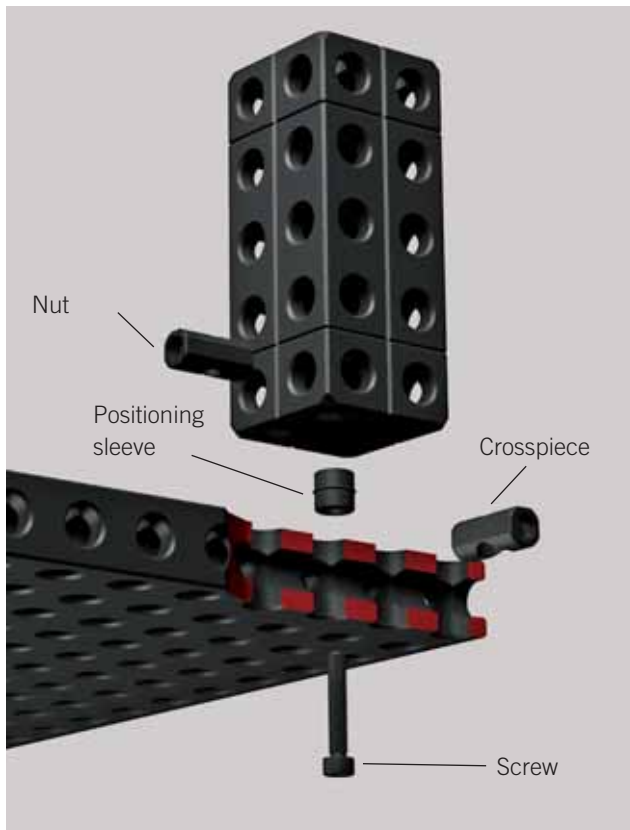

Screw connection

For lasting tight connections the screw connection has proved to be the best.



Lock Alufix

standard lock for quick connection

Nr.	System	A	B	C	
23250	AF 16	16	8	SW3	4

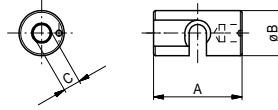

Twin bolt

for quick connection

Nr.	System	A	B	
23247	AF 16	8	15	3

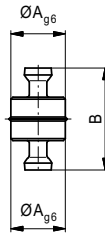

Twin bolt

for bar 1D and base plate 2

Nr.	System	A	B	C	
23248	AF 16	8	4	15	2

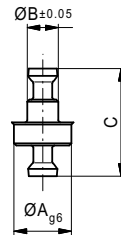

Combi bolt

Nr.	System	A	B	C	D	
23249	AF 16	8	17,7	M4	10,2	3

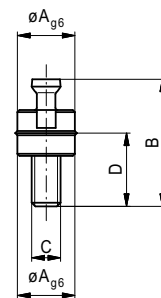

Combi bolt

shortened

Nr.	System	A	B	C	D	
25742	AF 16	8	14,2	M4	6,7	1

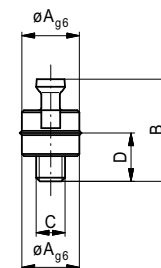

NewXS components can be anodized in different colours. Black (with suffix -1) is standard. Anodized natural is also available. Other colours on request.

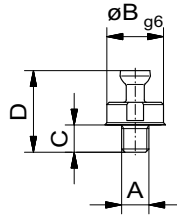

Combi bolt

for grid plate without fitted bore and keyless chuck

Nr.	System	A	B	C	D	
25746	AF16	M4	8	3,5	11	2

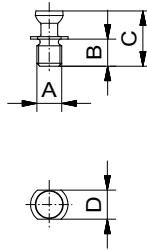

Combi bolt

shortened, for elements with nubs

Nr.	System	A	B	C	D	
20341	AF 16	M4	4,5	8,9	SW5	1

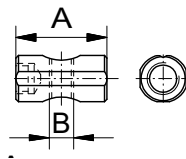

Crosspiece nut

for screw connection

Nr.	System	A	B	
80620-1	16	16	M3	2
80621-1	16	16	M4	2
81277-1	16	16	M3	2

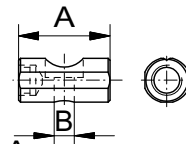

Crosspiece

for screw connection

Nr.	System	A	B	
21596-1	16	16	3,3	2
21597-1	16	16	4,3	2

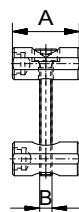

Connecting set

for screw connection

Nr.	System	A	B	
80697-1	16	16	M3	4
80698-1	16	16	M4	14

Positioning sleeve

AF 16

Nr.	A	B	C	g
324216-1	8	6	M5	1

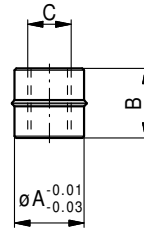

Positioning sleeve

plain

Nr.	A	B	C	g
21599-1	8	8	M5	1

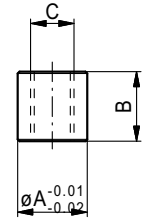

Hex socket head screw

DIN 912

Nr.	A	B	DIN	WAF	g
17255-S1	8	M4	7984	2,5	1
11546-S1	10	M4	7984	2,5	1
16141-S1	12	M4	7984	2,5	1,5
16359-S1	16	M4	7984	3	1,5

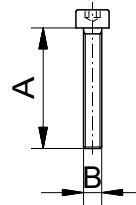

Standard thread sizes are printed in **bold print**

Tool

Nr.	WAF	g
17375	2	210
17374	2,5	220
17376	3	230



NewXS components can be anodized in different colours. Black (with suffix -1) is standard. Anodized natural is also available. Other colours on request.

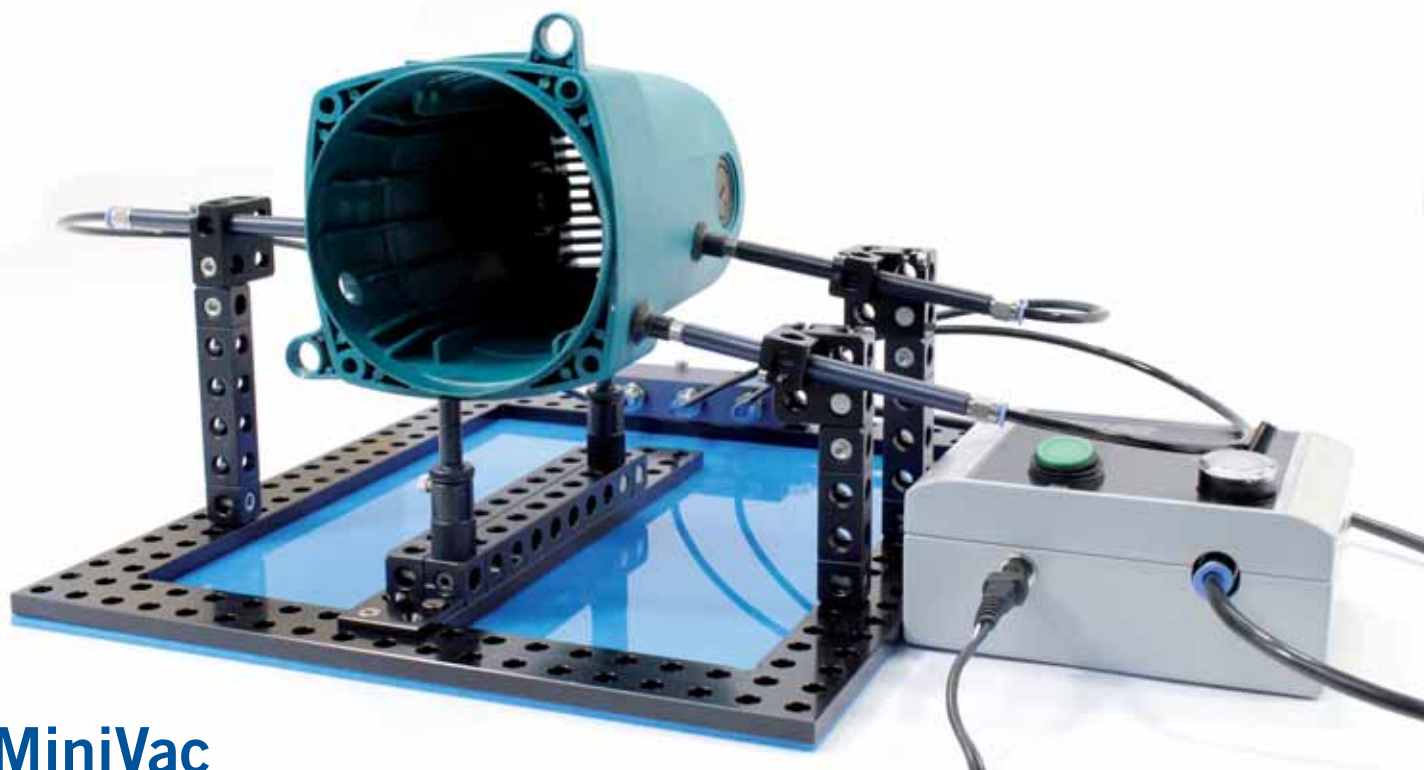

MiniVac

Vacuum clamping system

The MiniVac vacuum pump supplies air intake for up to 6 suckers using a minimum of space. An integrated tank with pressure difference switch prevents an abrupt drop in vacuum (and in worst case release of workpiece) and avoids pump running continuously.

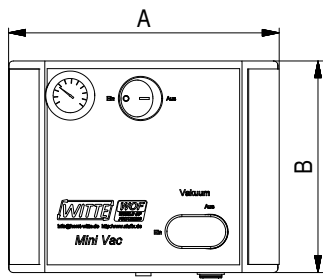
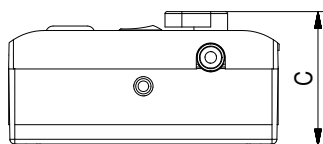

MiniVac pump

3500ccm/h

Nr.	A	B	C	
284752	140	110	70	480



- Operation via 220V power pack, integrated on/off switch with light display, vacuum switch and manometer. Double function membrane pump, max. 90° volume, 3500ccm/h. tank approx. 150ccm.

MiniVac Distributor

with 6 connections inc. 1m connection hose to vacuum pump

Nr.	A	B	C	
284753	90	47	20	180

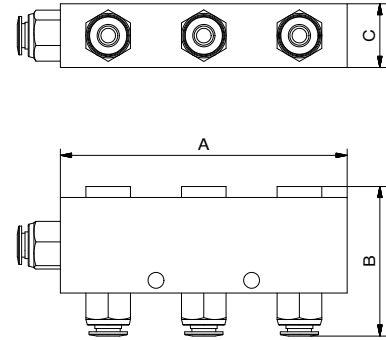
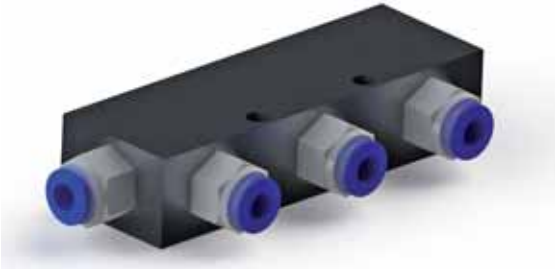

MiniVac Sucker

comprising: tube, sucker, connector

Nr.	A	B	C	
284391	100	10	8	20



The suckers have a standard diameter of 10mm and are made of NBR. Other materials, dimensions, forms (i.e. oval) on request.

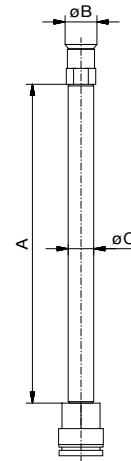

MiniVac – Suction hose

In PU, black

Nr.	D	L	
00958	6x1	1m	17



NewXS components can be anodized in different colours. Black (with suffix -1) is standard. Anodized natural is also available. Other colours on request.



Available on request

NewXS 10

Modular fixturing system for optical measuring and checking instruments

Components in system size New XS10
are available on request

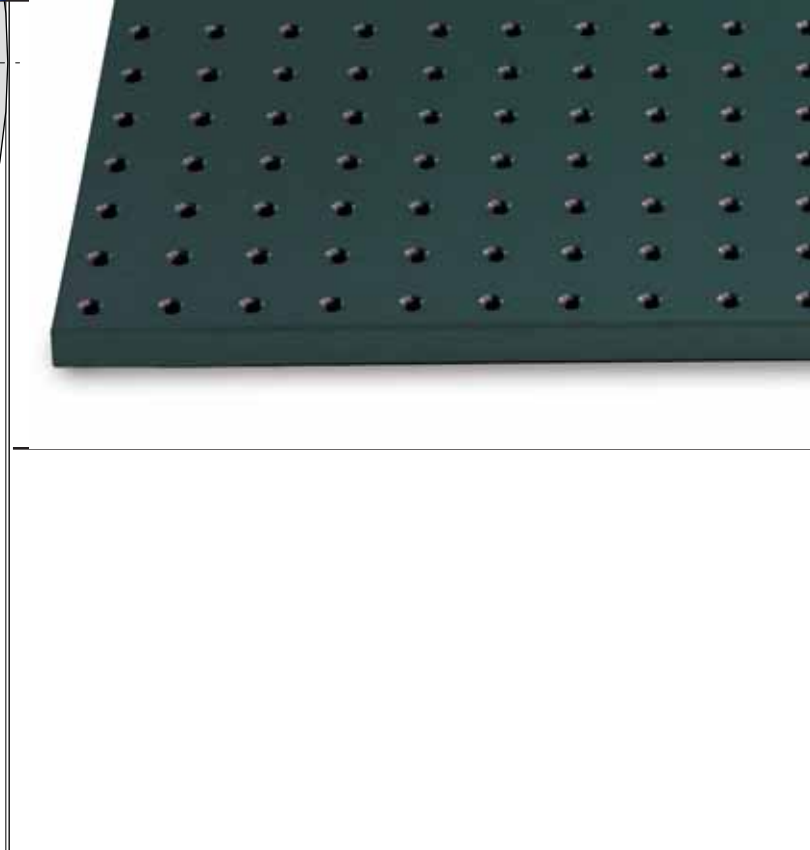
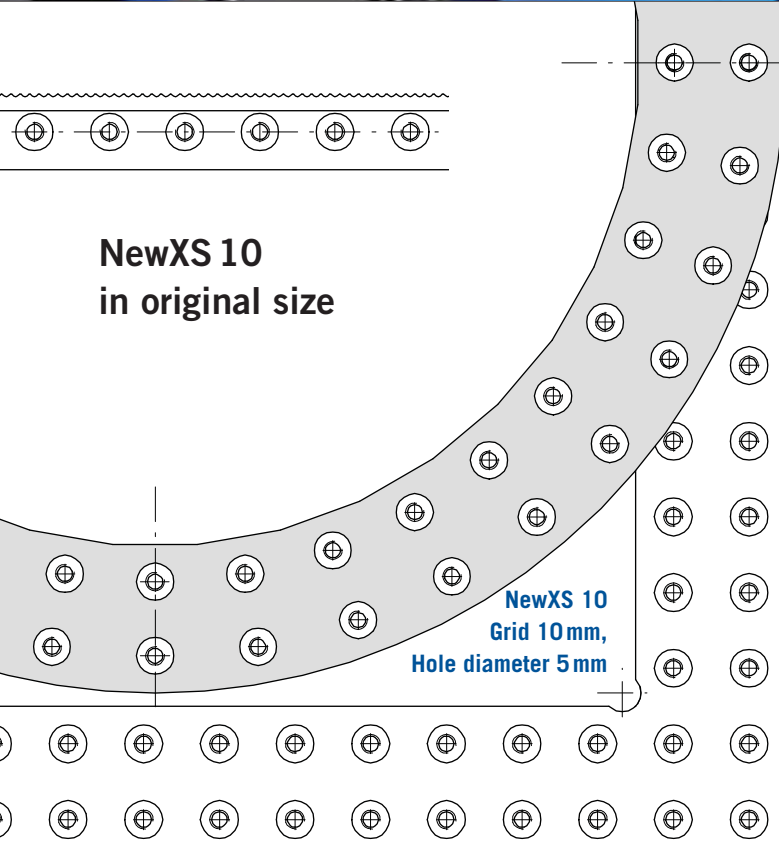
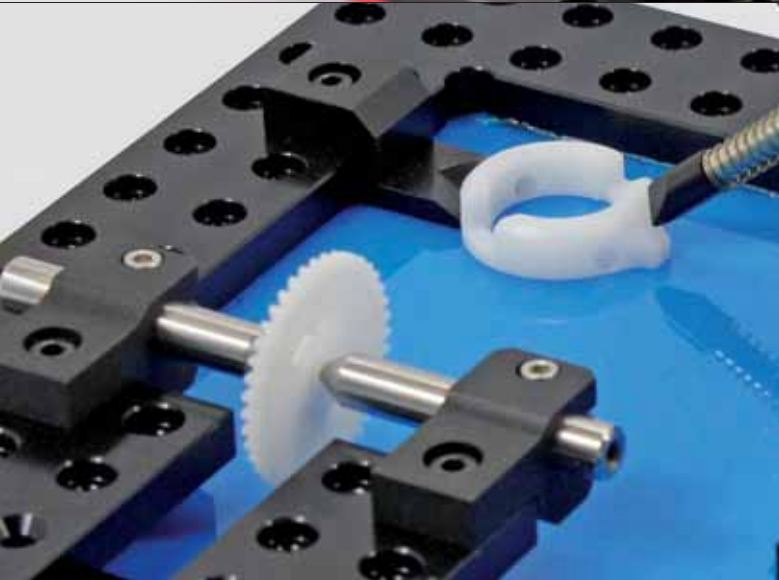

Index

- A**
 Adapter 24
 Adapter disc 25
 Adapter plate 11
 Adjustable fish-tongue 20
 ALUFIX 16 28
 Angle bracket 31
 Angle connecting lug 11
- B**
 Ball joint 24
 Bar 10
 Base plate 30
 Basic bar 12
 Basic Kit 26
- C**
 Center 13, 21
 Centerplate 37
 Clampholder 12
 Clamping ring 24
 Collet 23
 Collet chuck 23
 Combi bolt 39, 40
 Components 5, 7, 26, 28
 Connecting lug 11
 Connecting set 40
 Connection Elements 38
 Contents 1
 Cross roller slide 33
 Crosspiece 40
 Crosspiece nut 40
- D**
 Deflector 36
 Delta block 34
 Distributor 43
 Double knuckle 32
- F**
 Fixing disc 25
 Foot 20
 Full Bar 31
- G**
 Grid Base Plate 29
 Grid frame 8
 Grid ring 8
- H**
 Heel block 32
 Hex socket head screw 25, 41
 Hold-down column 16
 Hold-down spring 17, 18
- I**
 Introduction 3, 4, 5, 6
- K**
 Keyless Chuck 37
 Knife-V 22
 Knuckle 32
- L**
 Lock 39
- M**
 Magnetic Holder 22
 MiniVac 42, 43
- N**
 NewXS 10 44
- O**
 Original size 6, 28, 44
- P**
 Parallel clamp 19
 Pin 37
 Pincers 21
 Positioning sleeve 41
 Pump 42
 Push rod 18
- Q**
 Quick connection 38
- R**
 Reducer 20, 24
 Roller slide 33
- S**
 Screw 4, 38
 Screw connection 38
 Serrated bar 14
 Slide stop 33
 Stop 14, 15
 Stop and support 22
 Stop with clamp 9
 Sucker 43
 Suction hose 43
 Supporter 21
 Swivel 32
 Swivel arm 23
- T**
 Tailstock 13
 Telescopic unit 20
 Tool 25, 41
 Twin bolt 39
- V**
 V-piece 22, 35
 Vise 37
- W**
 Winder 36
 Winder tape 36



Inventing solutions.

Germany

Witte Barskamp KG

Horndorfer Weg 26-28
D-21354 Bleckede
Germany
Tel.: +49 (0) 58 54/89-0
Fax: +49 (0) 58 54/89-40

E-mail: info@witte-barskamp.de
www.witte-barskamp.de

Asia

Witte Far East Pte Ltd

20 Boon Lay Way
01 - 170
Singapore 609967
Singapore
Tel.: +65-6248 5961
Fax: +65-6898 4542

E-mail: info@witteasia.com
www.witteasia.com

USA & Canada

Witte LP

2220 Northmont Pkwy, Suite 250
Duluth, Georgia 30096
USA
Phone: +1 (770) 982 99 32
Fax: +1 (770) 982 99 28

E-mail: info@witteamerica.com
www.witteamerica.com

Mexico

Horst Witte de Mexico

S.A. de C.V.
Linco SC
2 Sur 1706, Col. El Carmen
Puebla, 72000
Mexico
Phone:
+52 222893-8210

E-mail: info@wittemexico.com
www.wittemexico.com

Witte –
specialized in

**Modular
fixturing systems**

**Premium
Subcontracting**

**Vacuum-
clamping systems**

